

Click to view price, real time Inventory,  
Delivery & Lifecycle Information ;

**770-103**

**WAGO**

3 Position Terminal Block Plug, Female Sockets 0.394" (10.00mm)  
180° Free Hanging (In-Line)

Any questions, please feel free to contact us.  
[info@kaimte.com](mailto:info@kaimte.com)

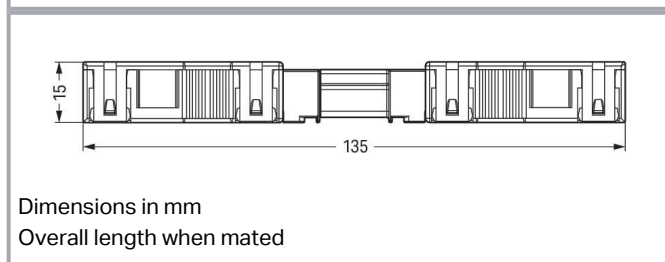
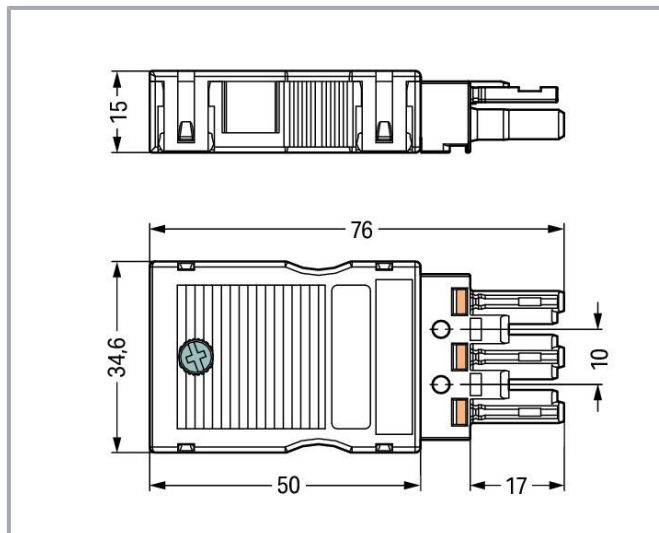

## Item description

### Female connector/socket WINSTA® MIDI with strain relief

The WINSTA® MIDI female connector/socket 3-pole provides the foundation for assembly of fine-stranded and solid conductors. WAGO pluggable installation connectors can be used when criteria repeat or are distributed on a defined grid, for example for installing grid lighting or flush-mount lighting. The mechanical coding and color coding of the pluggable installation connector ensure error-free installation of the individual components – including protection against mismatching. The WINSTA® MIDI pluggable installation connector with A coding in white or black is normally used for general mains applications in power distribution. This pluggable installation connector is designed for a load of up to 25 A. Therefore, it can also be used for high power loads. WINSTA® MIDI with Push-in CAGE CLAMP® spring pressure connection technology is used in can be found in a variety of projects you can use for quick, easy and maximally flexible installation. A range up to 55 mm can be used for the strip length.

### Lower costs through fast commissioning and elimination of service expenses – solutions from WINSTA® MIDI

Subject to changes. Please also observe the further product documentation!

WAGO GmbH & Co. KG  
Hansastr. 27  
32423 Minden  
Phone: +49571 887-0 | Fax: +49571 887-169  
Email: [info.de@wago.com](mailto:info.de@wago.com) | Web: [www.wago.com](http://www.wago.com)

Do you have any questions about our products?  
We are always happy to take your call at +49 (571) 887-44222.

The WINSTA® Pluggable Connection System is perfectly tailored to the strict requirements of building installation. It makes electrical installation pluggable, and therefore faster, more reliable, and error-free. Using this pre-assembled system decreases assembly times and errors during installation at the construction site. Choose quality and durability – with strain relief hosting from WAGO makes the electrical installation of electrical components visibly easier.

- 
- pluggable installation connectors with protection against mismatching
- pre-assembled versions
- with A coding for use in a large number of general mains applications
- ready to install and use immediately
- rapid, structured electrical installation

## Data

### Electrical data

#### Ratings per IEC/EN

Ratings per	IEC/EN 60664-1
Nominal voltage (III/3)	250 V
Rated impulse voltage (III/3)	4 kV
Rated current	25 A
Legend (ratings)	(III / 3) ≙ Overvoltage category III / Pollution degree 3

#### Ratings per UL 1977

Note for the US market	Some versions may also be used for current interruption in accordance with the UL certificate in select applications with currents below 16 A and voltages up to 600 V. For further information, please contact your local sales office.
Rated voltage (UL 1977)	600 V
Rated current UL 1977	23 A

### General information

Note on contact resistance	approx. 1 mΩ of contact resistance approx. 0.25 mΩ contact transition plug/socket
----------------------------	--

### Connection data

Connection points	6
-------------------	---

Subject to changes. Please also observe the further product documentation!

WAGO GmbH & Co. KG  
 Hansastr. 27  
 32423 Minden  
 Phone: +49571 887-0 | Fax: +49571 887-169  
 Email: [info.de@wago.com](mailto:info.de@wago.com) | Web: [www.wago.com](http://www.wago.com)

Do you have any questions about our products?  
 We are always happy to take your call at +49 (571) 887-44222.



Total number of potentials	3
Number of test slots	3

### Connection 1

Connection technology	Push-in CAGE CLAMP®
Actuation type	Operating tool Push-in
Nominal cross-section	4 mm <sup>2</sup> / 12 AWG
Solid conductor	0.5 ... 4 mm <sup>2</sup> / 20 ... 12 AWG
Solid conductor; push-in termination	1.5 ... 4 mm <sup>2</sup> / 16 ... 12 AWG
Stranded conductor	0.5 ... 2.5 mm <sup>2</sup> / 20 ... 14 AWG
Fine-stranded conductor	0.5 ... 4 mm <sup>2</sup> / 20 ... 12 AWG
Fine-stranded conductor; with insulated ferrule	0.25 ... 1.5 mm <sup>2</sup> / 20 ... 16 AWG
Fine-stranded conductor; with uninsulated ferrule	0.25 ... 2.5 mm <sup>2</sup> / 20 ... 14 AWG
Fine-stranded conductor; with ferrule; push-in termination	1.5 mm <sup>2</sup> / 16 AWG
Strip length	9 mm / 0.35 inches
Pole number	3
Connectable sheathed cable diameter	8 ... 11.5 mm
Conductor entry direction to mating direction	0°
Strip length (outer insulation)	55 mm

### Physical data

Pin spacing	10 mm / 0.394 inches
Width	34.6 mm / 1.362 inches
Height	15 mm / 0.591 inches
Depth	76 mm / 2.992 inches

### Mechanical Data

Application	General mains applications
Coding	A
Variable coding	Yes
Marking	L ⊥ N
Potential marking	L ⊥ N
Mating force of a plug-in connection	approx. 20 ... 70 N (depending on pole number)
Retention force of a plug-in connection	Locked: > 80 N
Unmating force of a plug-in connection	Unlocked: approx. 20 ... 70 N (depending on pole number)
Number of mating cycles	200, without resistive load

Subject to changes. Please also observe the further product documentation!

WAGO GmbH & Co. KG  
 Hansastr. 27  
 32423 Minden  
 Phone: +49571 887-0 | Fax: +49571 887-169  
 Email: [info.de@wago.com](mailto:info.de@wago.com) | Web: [www.wago.com](http://www.wago.com)

Do you have any questions about our products?  
 We are always happy to take your call at +49 (571) 887-44222.



Protection type	IP2XC; When mated and secured with a strain relief housing: IP2xC (These compact connectors are not designed for use in open, easily accessible areas!)
-----------------	--

## Plug-in connection

Contact type (pluggable connector)	Female connector/socket
Connector (connection type)	for conductor
Mismating protection	Yes
Note on mismating protection	All WINSTA® components are 100% protected against mismating when: a.) plugging different numbers of poles b.) plugging while rotated 180 c.) plugging while laterally staggered d.) plugging one pole
Locking lever	Can be retrofitted
Locking of plug-in connection	locking lever
Note on locking system	All connectors for mounted installations (snap-in versions for lighting fixtures or devices, all types of PCB and distribution connectors) are factory-equipped with locking levers to ensure plugs and sockets are securely locked. Additional locking levers are only required for flying leads (plug/socket).
Strain relief	strain relief housing

## Material data

Note (material data)	Information on material specifications can be found here
Color	black
Cover color	gray
Material group	I
Insulation material	Polyamide (PA66)
Flammability class per UL94	V0
Clamping spring material	Chrome-nickel spring steel (CrNi)
Contact material	Copper or copper alloy; surface-treated
Contact plating	Tin
Fire load	0.447 MJ
Strain relief color	black
Weight	20 g

Subject to changes. Please also observe the further product documentation!

WAGO GmbH & Co. KG  
Hansastr. 27  
32423 Minden  
Phone: +49571 887-0 | Fax: +49571 887-169  
Email: [info.de@wago.com](mailto:info.de@wago.com) | Web: [www.wago.com](http://www.wago.com)

Do you have any questions about our products?  
We are always happy to take your call at +49 (571) 887-44222.

## Environmental requirements

Processing temperature	-5 ... +40 °C
Continuous operating temperature	-35 ... +85 °C
Note on continuous operating temperature	Insulating parts for temperatures ≤ 105 °C

## Commercial data



Product Group	20 (Winsta)
eCl@ss 10.0	27-44-06-05
eCl@ss 9.0	27-44-06-05
ETIM 8.0	EC002560
ETIM 7.0	EC002560
PU (SPU)	25 pcs
Packaging type	box
Country of origin	DE
GTIN	4044918252096
Customs tariff number	85366990990

## Environmental Product Compliance

RoHS Compliance Status	Compliant, No Exemption
------------------------	-------------------------

## Approvals / Certificates



### General approvals

Logo	Approval	Additional Approval Text	Certificate name
	CCA DEKRA Certification B.V.	EN 61535	71- 123228
	CCA DEKRA Certification B.V.	IEC 61535	NL -84761
	cURus Underwriters Laboratories Inc.	UL 1977	E45171
	cURus Underwriters Laboratories Inc.	UL 1059	E 45172

Subject to changes. Please also observe the further product documentation!

WAGO GmbH & Co. KG  
Hansastr. 27  
32423 Minden  
Phone: +49571 887-0 | Fax: +49571 887-169  
Email: [info.de@wago.com](mailto:info.de@wago.com) | Web: [www.wago.com](http://www.wago.com)



Do you have any questions about our products?  
We are always happy to take your call at +49 (571) 887-44222.

	VDE VDE Prüf- und Zertifizierungsinstitut	EN 61535	40029808
	VDE VDE Prüf- und Zertifizierungsinstitut	EN 61984	40002889



## Declarations of conformity and manufacturer's declarations

Logo	Approval	Additional Approval Text	Certificate name
	EU-Declaration of Conformity WAGO GmbH & Co. KG	-	-

## Approvals for marine applications

Logo	Approval	Additional Approval Text	Certificate name
	ABS American Bureau of Shipping	-	19- HG1868589- PDA
	DNV GL Det Norske Veritas, Germanischer Lloyd	-	TAE00001Z6
	LR Lloyds Register	IEC 61984	LR22429487TA

## Counterpart

	Item no.770-113 Plug; with strain relief housing; 3-pole; Cod. A; 4,00 mm <sup>2</sup> ; black	<a href="http://www.wago.com/770-113">www.wago.com/770-113</a>
	Item no.770-213 Plug; 3-pole; Cod. A; 4,00 mm <sup>2</sup> ; black	<a href="http://www.wago.com/770-213">www.wago.com/770-213</a>
	Item no.770-213/035-000 Plug; with strain relief housing; 3-pole; Cod. A; 4,00 mm <sup>2</sup> ; black	<a href="http://www.wago.com/770-213/035-000">www.wago.com/770-213/035-000</a>

Subject to changes. Please also observe the further product documentation!

WAGO GmbH & Co. KG  
Hansastr. 27  
32423 Minden  
Phone: +49571 887-0 | Fax: +49571 887-169  
Email: [info.de@wago.com](mailto:info.de@wago.com) | Web: [www.wago.com](http://www.wago.com)

Do you have any questions about our products?  
We are always happy to take your call at +49 (571) 887-44222.

	<b>Item no.770-213/002-000</b> Plug; with direct ground contact; 3-pole; Cod. A; 4,00 mm <sup>2</sup> ; black	<a href="http://www.wago.com/770-213/002-000">www.wago.com/770-213/002-000</a>
	<b>Item no.770-606</b> T-distribution connector; 3-pole; Cod. A; 1 input; 2 outputs; 2 locking levers; black	<a href="http://www.wago.com/770-606">www.wago.com/770-606</a>
	<b>Item no.770-607</b> 3-way distribution connector; 3-pole; Cod. A; 1 input; 3 outputs; black	<a href="http://www.wago.com/770-607">www.wago.com/770-607</a>
	<b>Item no.770-608</b> 5-way distribution connector; 3-pole; Cod. A; 1 input; 5 outputs; outputs on both sides; black	<a href="http://www.wago.com/770-608">www.wago.com/770-608</a>
	<b>Item no.770-615</b> T-distribution connector; 3-pole; Cod. A; 1 input; 2 outputs; 3 locking levers; for flying leads; black	<a href="http://www.wago.com/770-615">www.wago.com/770-615</a>
	<b>Item no.770-633</b> h-distribution connector; 3-pole; Cod. A; 1 input; 2 outputs; 2 locking levers; black	<a href="http://www.wago.com/770-633">www.wago.com/770-633</a>
	<b>Item no.770-635</b> h-distribution connector; 3-pole; Cod. A; 1 input; 2 outputs; outputs on both sides; 3 locking levers; for flying leads; black	<a href="http://www.wago.com/770-635">www.wago.com/770-635</a>
	<b>Item no.770-634</b> h-distribution connector; 3-pole; Cod. A; 1 input; 2 outputs; outputs on one side; 2 locking levers; black	<a href="http://www.wago.com/770-634">www.wago.com/770-634</a>
	<b>Item no.770-637</b> Distribution connector for switches; Single-pole switch and series circuit; 3-pole; Cod. A/S; 1 input; 5 outputs; black	<a href="http://www.wago.com/770-637">www.wago.com/770-637</a>
	<b>Item no.770-636</b> h-distribution connector; 3-pole; Cod. A; 1 input; 2 outputs; outputs on one side; 3 locking levers; for flying leads; black	<a href="http://www.wago.com/770-636">www.wago.com/770-636</a>
	<b>Item no.770-713</b> Snap-in plug; 3-pole; Cod. A; 4,00 mm <sup>2</sup> ; black	<a href="http://www.wago.com/770-713">www.wago.com/770-713</a>
	<b>Item no.770-638</b> Distribution connector for switches; Single-pole and throttle two-way circuit; 3-pole; Cod. A/S; 1 input; 5 outputs; black	<a href="http://www.wago.com/770-638">www.wago.com/770-638</a>
	<b>Item no.770-813</b> Plug for PCBs; straight; 3-pole; Cod. A; black	<a href="http://www.wago.com/770-813">www.wago.com/770-813</a>
	<b>Item no.770-713/007-000</b> Snap-in plug; with direct ground contact; 3-pole; Cod. A; 4,00 mm <sup>2</sup> ; black	<a href="http://www.wago.com/770-713/007-000">www.wago.com/770-713/007-000</a>
	<b>Item no.771-9993/006-101</b> pre-assembled interconnecting cable; Eca; Socket/plug; 3-pole; Cod. A; H05VV-F 3G 1.5 mm <sup>2</sup> ; 1 m; 1,50 mm <sup>2</sup> ; black	<a href="http://www.wago.com/771-9993/006-101">www.wago.com/771-9993/006-101</a>

Subject to changes. Please also observe the further product documentation!

WAGO GmbH & Co. KG  
Hansastr. 27  
32423 Minden  
Phone: +49571 887-0 | Fax: +49571 887-169  
Email: [info.de@wago.com](mailto:info.de@wago.com) | Web: [www.wago.com](http://www.wago.com)

Do you have any questions about our products?  
We are always happy to take your call at +49 (571) 887-44222.





**Item no. 770-813/011-000**  
Plug for PCBs; angled; 3-pole; Cod. A; black

[www.wago.com/770-813/011-000](http://www.wago.com/770-813/011-000)



**Item no. 771-9993/206-101**  
pre-assembled connecting cable; Eca; Plug/open-ended; 3-pole; Cod. A; H05VV-F 3G 1.5 mm<sup>2</sup>; 1 m; 1,50 mm<sup>2</sup>; black

[www.wago.com/771-9993/206-101](http://www.wago.com/771-9993/206-101)

## Required accessories

### Locking levers

#### Locking system



**Item no.: 770-121**  
Locking lever; for flying leads; for manual operation; white

[www.wago.com/770-121](http://www.wago.com/770-121)



**Item no.: 770-131**  
Locking lever; for flying leads; for tool operation; white

[www.wago.com/770-131](http://www.wago.com/770-131)



**Item no.: 770-101**  
Locking lever; for flying leads; for manual operation; black

[www.wago.com/770-101](http://www.wago.com/770-101)



**Item no.: 770-111**  
Locking lever; for flying leads; for tool operation; black

[www.wago.com/770-111](http://www.wago.com/770-111)

## Optional accessories

### Cover

#### Cover



**Item no.: 770-201**  
Lockout cap; 12-pole, separable; for sockets; Plastic; black

[www.wago.com/770-201](http://www.wago.com/770-201)



**Item no.: 770-221**  
Lockout cap; 12-pole, separable; for sockets; Plastic; white

[www.wago.com/770-221](http://www.wago.com/770-221)

### Tool

#### Operating tool



**Item no.: 210-719**  
Operating tool; Blade: 2.5 x 0.4 mm; with a partially insulated shaft

[www.wago.com/210-719](http://www.wago.com/210-719)



**Item no.: 770-383**  
Operating tool; 3-way; green

[www.wago.com/770-383](http://www.wago.com/770-383)

### Marking accessories

Subject to changes. Please also observe the further product documentation!

WAGO GmbH & Co. KG  
Hansastr. 27  
32423 Minden  
Phone: +49571 887-0 | Fax: +49571 887-169  
Email: [info.de@wago.com](mailto:info.de@wago.com) | Web: [www.wago.com](http://www.wago.com)

Do you have any questions about our products?  
We are always happy to take your call at +49 (571) 887-44222.

Marker

	<b>Item no.: 770-450/000-002</b> Marker card; Plastic; yellow	<a href="http://www.wago.com/770-450/000-002">www.wago.com/770-450/000-002</a>
	<b>Item no.: 770-450/000-001</b> Marker card; Plastic; green	<a href="http://www.wago.com/770-450/000-001">www.wago.com/770-450/000-001</a>
	<b>Item no.: 770-450/000-005</b> Marker card; Plastic; red	<a href="http://www.wago.com/770-450/000-005">www.wago.com/770-450/000-005</a>
	<b>Item no.: 770-450</b> Marker card; Plastic; white	<a href="http://www.wago.com/770-450">www.wago.com/770-450</a>
	<b>Item no.: 770-450/000-006</b> Marker card; Plastic; blue	<a href="http://www.wago.com/770-450/000-006">www.wago.com/770-450/000-006</a>
	<b>Item no.: 770-450/000-012</b> Marker card; Plastic; orange	<a href="http://www.wago.com/770-450/000-012">www.wago.com/770-450/000-012</a>

Downloads

Documentation

Bid Text

770-103 X81 - Datei	2019 年2月19日	xml 3.1 kB	Download
770-103 doc - Datei	2015 年6月8日	doc 24.1 kB	Download
ausschreiben.de 770-103		URL	Download

CAD/CAE-Data

CAD data

2D/3D Models 770-103	URL	Download
----------------------	-----	----------

CAE data

EPLAN Data Portal 770-103	URL	Download
---------------------------	-----	----------

Subject to changes. Please also observe the further product documentation!

WAGO GmbH & Co. KG  
 Hansastr. 27  
 32423 Minden  
 Phone: +49571 887-0 | Fax: +49571 887-169  
 Email: [info.de@wago.com](mailto:info.de@wago.com) | Web: [www.wago.com](http://www.wago.com)

Do you have any questions about our products?  
 We are always happy to take your call at +49 (571) 887-44222.

WSCAD Universe 770-103	<a href="#">URL</a>	<a href="#">Download</a>
ZUKEN Portal 770-103	<a href="#">URL</a>	<a href="#">Download</a>
<b>Asset Administration Shell</b>		
Asset Administration Shell 770-103	<a href="#">URL</a>	<a href="#">Download</a>

## Environmental Product Compliance

### Compliance Search

Environmental Product Compliance 770-103	<a href="#">URL</a>	<a href="#">Download</a>
Socket; with strain relief housing; 3-pole; Cod. A; 4,00 mm <sup>2</sup> ; black		

## Installation Notes

### Conductor termination

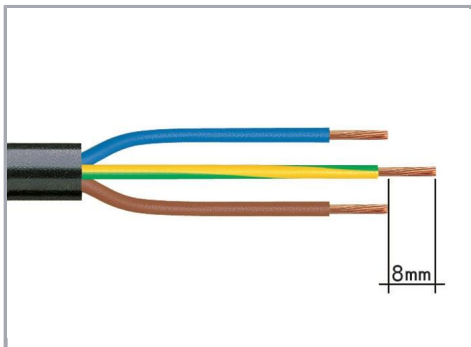

1. Strip length, outer insulation = 35 mm (2-pole), 55 mm (3- to 5-pole)
2. Strip length = 9 mm
3. Extended ground conductor = 8 mm

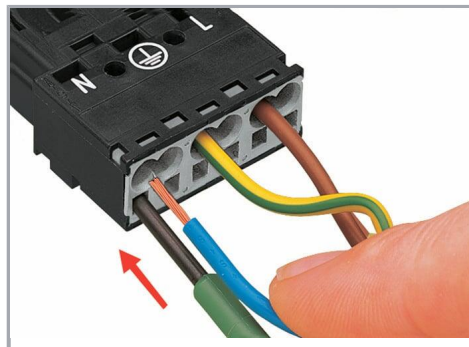

To terminate fine-stranded conductors, open the clamping unit via screwdriver (2.5 mm blade width) and insert a stripped conductor until it hits the backstop.

Subject to changes. Please also observe the further product documentation!

WAGO GmbH & Co. KG  
Hansastr. 27  
32423 Minden  
Phone: +49571 887-0 | Fax: +49571 887-169  
Email: [info.de@wago.com](mailto:info.de@wago.com) | Web: [www.wago.com](http://www.wago.com)

Do you have any questions about our products?  
We are always happy to take your call at +49 (571) 887-44222.

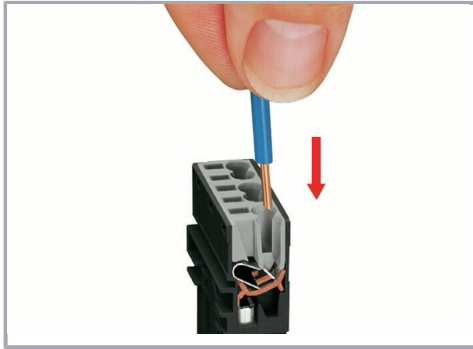

Insert the stripped solid conductor until it hits the backstop.

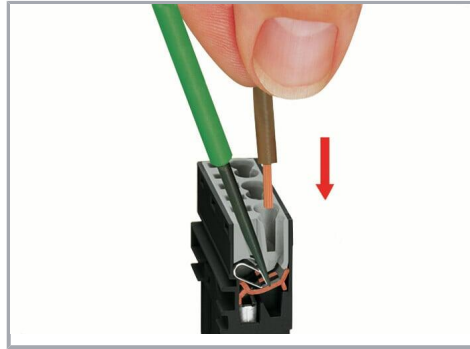

To terminate fine-stranded conductors, open the clamping unit via screwdriver (2.5 mm blade width) and insert a stripped conductor until it hits the backstop.

#### Conductor removal

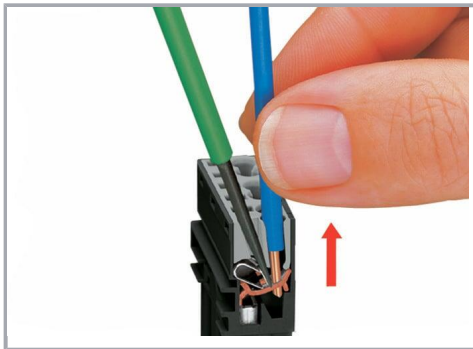

To remove the conductor, actuate the clamp via screwdriver (2.5 mm blade width) and pull out the conductor.

#### Installation

Subject to changes. Please also observe the further product documentation!

WAGO GmbH & Co. KG  
Hansastr. 27  
32423 Minden  
Phone: +49571 887-0 | Fax: +49571 887-169  
Email: [info.de@wago.com](mailto:info.de@wago.com) | Web: [www.wago.com](http://www.wago.com)

Do you have any questions about our products?  
We are always happy to take your call at +49 (571) 887-44222.

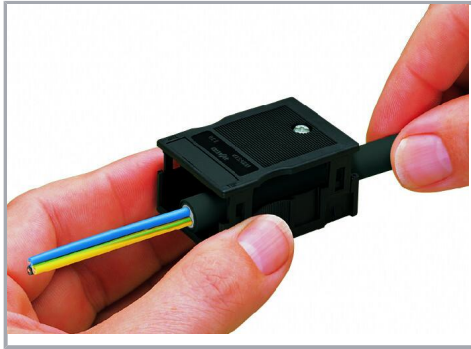

We recommend pulling the pre-latched strain relief housing over the cable prior to termination. However, the strain relief can be mounted at a later time as well.

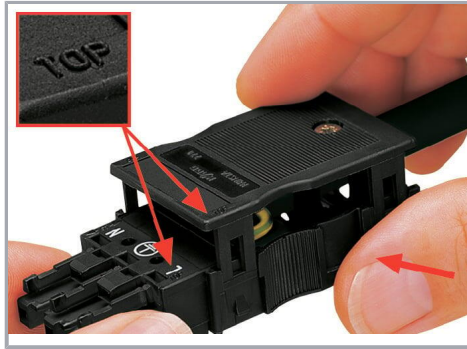

Latch the strain relief housing onto the plug /socket. Note the "TOP" inscription.

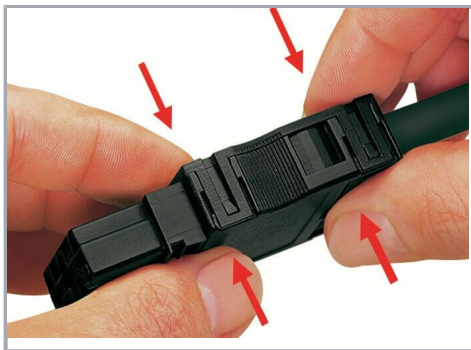

Prepare strain relief housing by snapping together upper and bottom part.



Tighten strain relief screw with screwdriver (2.5 mm blade width).

### Coding



Simply cut off the coding pin from the socket.

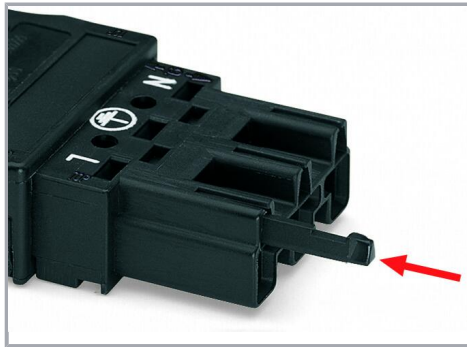

Insert coding pin into plug (break first) until it engages.

### Shield termination

Subject to changes. Please also observe the further product documentation!

WAGO GmbH & Co. KG  
Hansastr. 27  
32423 Minden  
Phone: +49571 887-0 | Fax: +49571 887-169  
Email: [info.de@wago.com](mailto:info.de@wago.com) | Web: [www.wago.com](http://www.wago.com)

Do you have any questions about our products?  
We are always happy to take your call at +49 (571) 887-44222.

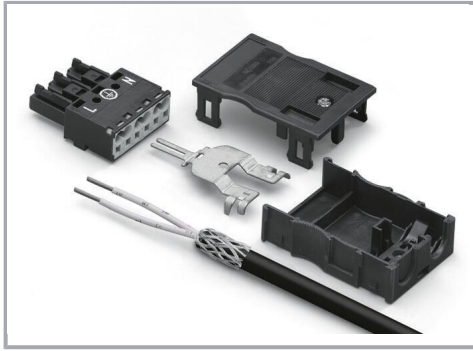

Connector with shield termination

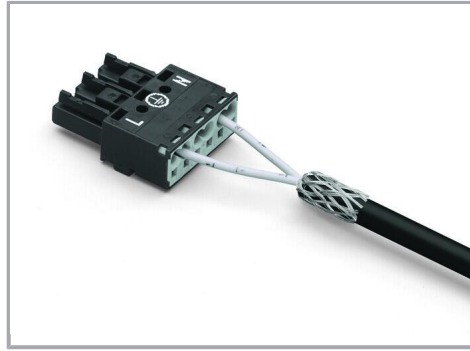

Apply the shield to the sheathed cable.

Strip length, outer insulation = 55 mm

Shield length = 10 mm

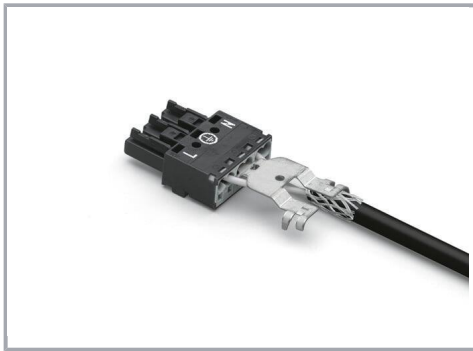

Push the shield connecting plate into the connector until fully inserted.

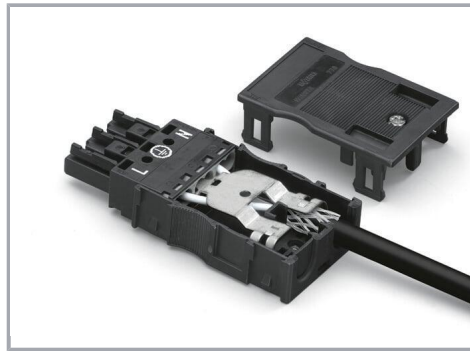

First insert the wired connector into a strain relief housing, then snap cover and tighten screw.

## Product family

**WINSTA® MIDI**

[Show all products from the family](#)

Subject to changes. Please also observe the further product documentation!

WAGO GmbH & Co. KG  
Hansastr. 27  
32423 Minden  
Phone: +49571 887-0 | Fax: +49571 887-169  
Email: [info.de@wago.com](mailto:info.de@wago.com) | Web: [www.wago.com](http://www.wago.com)

Do you have any questions about our products?  
We are always happy to take your call at +49 (571) 887-44222.