

Product Overview

The CMD262 is a 5 W GaN MMIC power amplifier die ideally suited for Ka-band communications systems where high power and high linearity are needed. The device delivers greater than 24 dB of gain with a corresponding output 1 dB compression point of +37 dBm and a saturated output power of +38 dBm at 29% power added efficiency. The CMD262 is a 50 ohm matched design eliminating the need for external DC blocks and RF port matching. The CMD262 offers full passivation for increased reliability and moisture protection.

Key Features

- High Power
- High Linearity
- Excellent Efficiency
- Small Die Size: 2720 um x 1520 um

Ordering Information

Part No.	Description
CMD262	26-28 GHz GaN Power Amplifier, 10 Piece Gel Pack

Functional Block Diagram

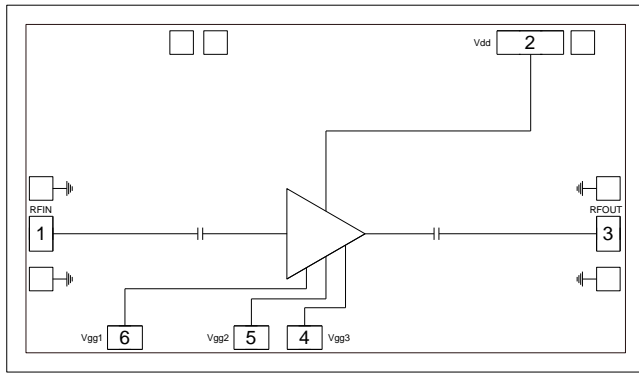

Electrical Performance ($V_{dd} = 28\text{ V}$, $V_{gg1} = V_{gg2} = V_{gg3} = -4\text{ V}$, $T_A = 25\text{ °C}$, $F = 27\text{ GHz}$)

Parameter	Min	Typ	Max	Units
Frequency Range		26 - 28		GHz
Gain		24		dB
Output P1dB		37		dBm
Output Psat		38		dBm
Input Return Loss		20		dB
Output Return Loss		10		dB
Supply Current		350		mA

Absolute Maximum Ratings

Parameter	Rating
Drain Voltage, V_{dd}	32 V
Gate Voltage, $V_{gg1, 2, 3}$	-10 V
RF Input Power	+25 dBm
Channel Temperature, T_{ch}	175 °C
Power Dissipation, P_{diss}	18.2 W
Thermal Resistance, θ_{JC}	4.93 °C/W
Operating Temperature	-55 to 85 °C
Storage Temperature	-55 to 150 °C

Exceeding any one or combination of the maximum ratings may cause permanent damage to the device.

Recommended Operating Conditions

Parameter	Min	Typ	Max	Units
V_{dd}	20	28	30	V
I_{dd}		350		mA
$V_{gg1, 2, 3}$	-5	-4	-3	V

Electrical performance is measured at specific test conditions. Electrical specifications are not guaranteed over all recommended operating conditions.

Electrical Performance ($V_{dd} = 28$ V, $V_{gg1} = V_{gg2} = V_{gg3} = -4$ V, $T_A = 25$ °C)

Parameter	Min	Typ	Max	Units
Frequency Range	26 - 28			GHz
Gain	19	24		dB
Input Return Loss		15		dB
Output Return Loss		11		dB
Output P1dB	34	37		dBm
Psat		38		dBm
Power Added Efficiency		28		%
Supply Current	250	350	450	mA

Typical Performance

Broadband Performance, $V_{dd} = 28\text{ V}$, $V_{gg1, 2, 3} = -4\text{ V}$, $I_{dd} = 350\text{ mA}$, $T_A = 25\text{ °C}$

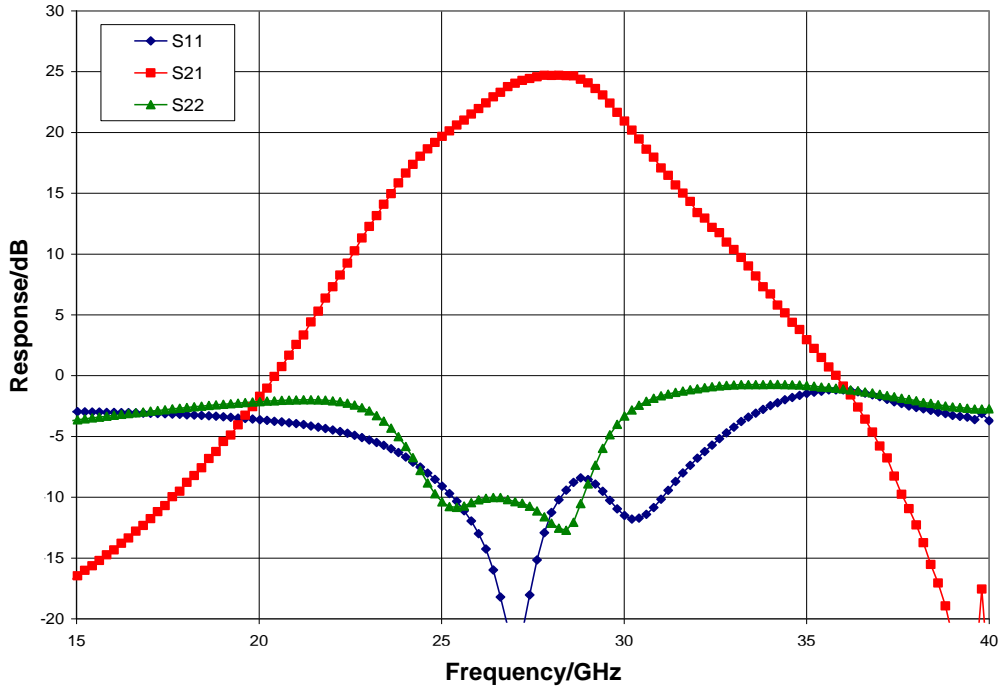

Narrow-band Performance, $V_{dd} = 28\text{ V}$, $V_{gg1, 2, 3} = -4\text{ V}$, $I_{dd} = 350\text{ mA}$, $T_A = 25\text{ °C}$

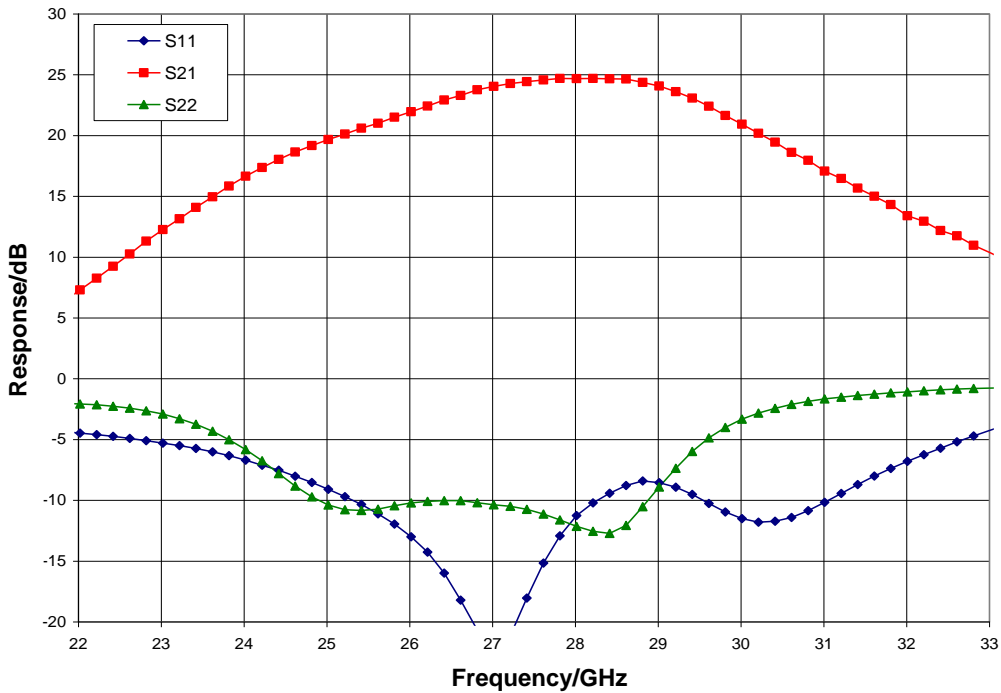

Typical Performance

Output Power and Power Added Efficiency, $V_{dd} = 28\text{ V}$, $V_{gg1, 2, 3} = -4\text{ V}$, $T_A = 25\text{ °C}$

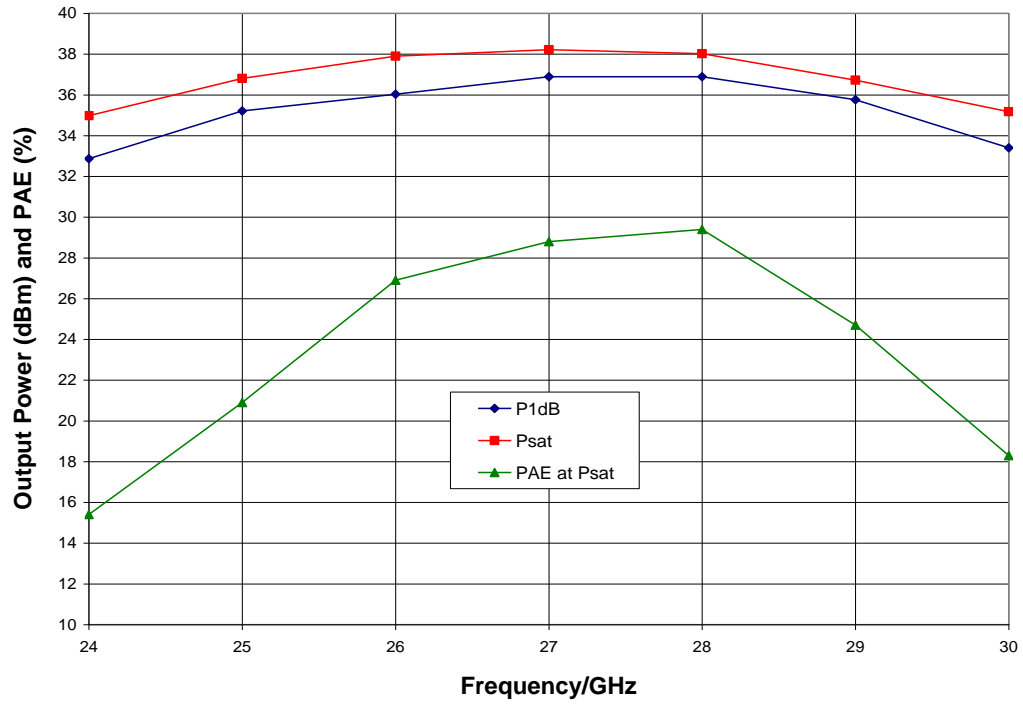

Mechanical Information

Die Outline (all dimensions in microns)

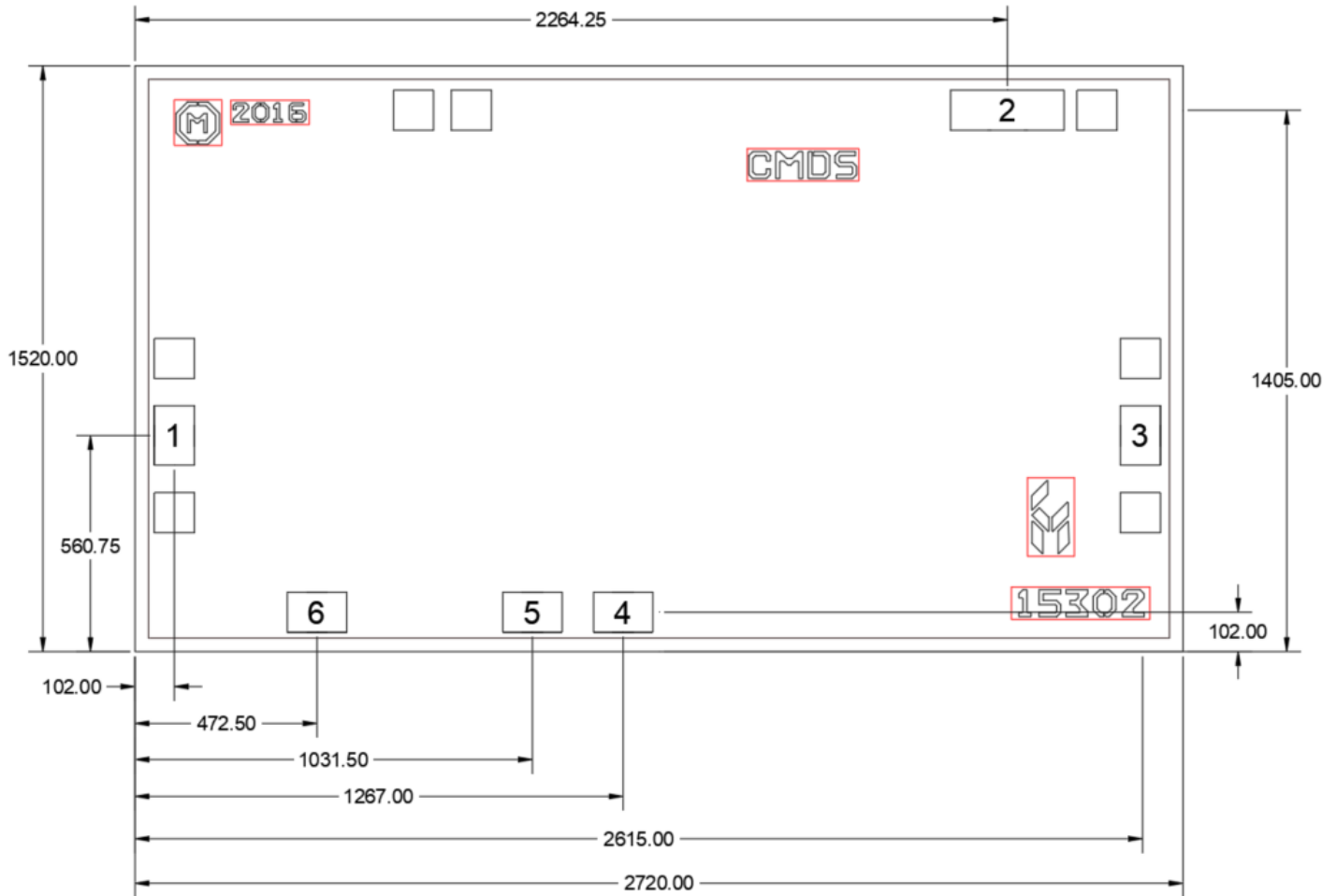

Notes:

1. No connection required for unlabeled pads
2. Backside is RF and DC ground
3. Backside and bond pad metal: Gold
4. Die is 100 microns thick
5. RF bond pads (1, 3) are 100 x 150 microns
6. DC bond pad (2) is 100 x 300 microns
7. DC bond pads (4, 5, 6) are 100 x 150 microns

Pin Description

Pad Diagram

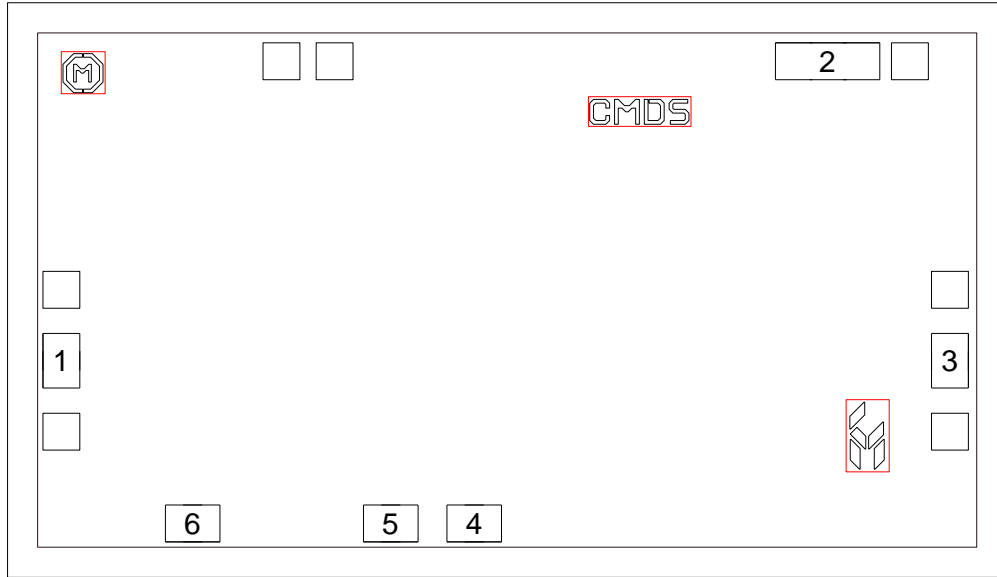

Functional Description

Pad	Function	Description	Schematic
1	RF in	DC blocked and 50 ohm matched	
2	V _{dd}	Power supply voltage Decoupling and bypass caps required	
3	RF out	DC blocked and 50 ohm matched	
4, 5, 6	V _{gg3, 2, 1}	Power supply voltage Decoupling and bypass caps required	
Backside	Ground	Connect to RF / DC ground.	

Applications Information

Assembly Guidelines

The backside of the CMD262 is RF ground. Die attach should be accomplished with electrically and thermally conductive epoxy or eutectic attach. Standard assembly procedures should be followed for high frequency devices. The top surface of the semiconductor should be made planar to the adjacent RF transmission lines, and the RF decoupling capacitors placed in close proximity to the DC connections on chip.

RF connections should be made as short as possible to reduce the inductive effect of the bond wire. Use of a 0.8 mil thermosonic wedge bonding is highly recommended as the loop height will be minimized. The RF input and output require double bond wires as shown.

The semiconductor is 100 μm thick and should be handled by the sides of the die or with a custom collet. Do not make contact directly with the die surface as this will damage the monolithic circuitry. Handle with care.

Assembly Diagram

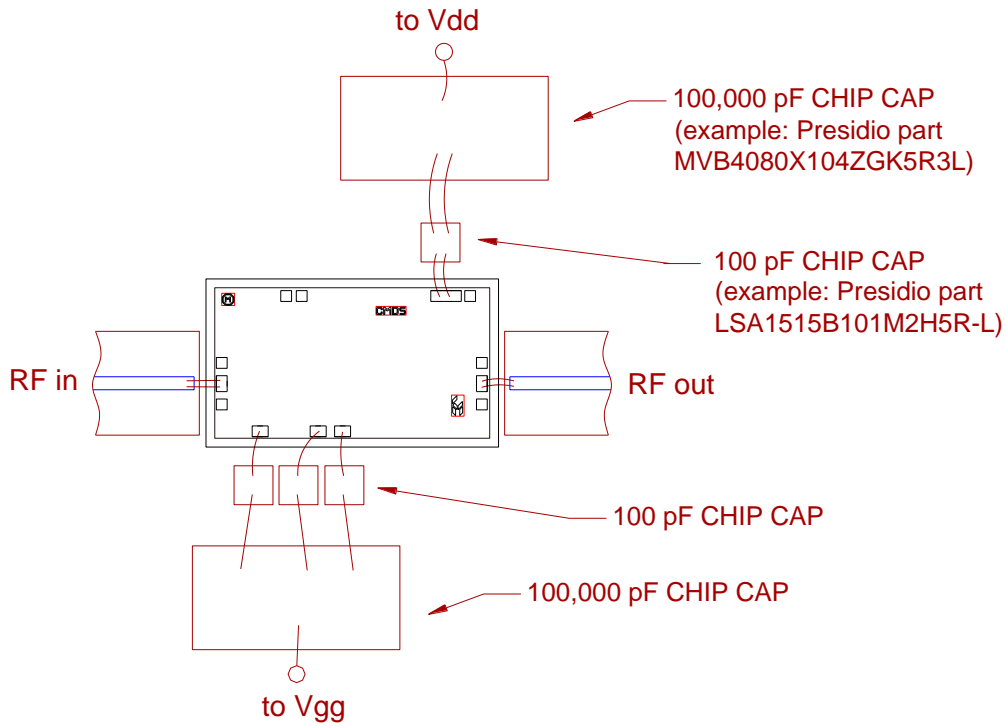

GaAs MMIC devices are susceptible to damage from Electrostatic Discharge. Proper precautions should be observed during handling, assembly and test.

Applications Information

Biasing and Operation

The CMD262 is biased with a positive drain supply and a negative gate supply. Performance is optimized when the drain voltage is set to +28 V. The nominal gate voltage is -4 V.

Turn ON procedure:

1. Apply gate voltage V_{gg} and set to -6 V
2. Apply drain voltage V_{dd} and set to +28 V
3. Increase V_{gg} (less negative) to achieve a drain current of 350 mA

Turn OFF procedure:

1. Turn off drain voltage V_{dd}
2. Turn off gate voltage V_{gg}

RF power can be applied at any time.

Handling Precautions

Parameter	Rating	Standard
ESD – Human Body Model (HBM)	Class 1A	ESDA / JEDEC JS-001-2012



Caution!
 ESD-Sensitive Device

RoHS Compliance

This part is compliant with 2011/65/EU RoHS directive (Restrictions on the Use of Certain Hazardous Substances in Electrical and Electronic Equipment) as amended by Directive 2015/863/EU.

This product also has the following attributes:

- Lead Free
- Antimony Free
- TBBP-A (C₁₅H₁₂Br₄O₂) Free
- SVHC Free
- Halogen Free
- PFOS Free

Contact Information

For the latest specifications, additional product information, worldwide sales and distribution locations:

Web: www.qorvo.com

Tel: 1-844-890-8163

Email: customer.support@qorvo.com

Important Notice

The information contained in this Data Sheet and any associated documents (“Data Sheet Information”) is believed to be reliable; however, Qorvo makes no warranties regarding the Data Sheet Information and assumes no responsibility or liability whatsoever for the use of said information. All Data Sheet Information is subject to change without notice. Customers should obtain and verify the latest relevant Data Sheet Information before placing orders for Qorvo® products. Data Sheet Information or the use thereof does not grant, explicitly, implicitly or otherwise any rights or licenses to any third party with respect to patents or any other intellectual property whether with regard to such Data Sheet Information itself or anything described by such information.

DATA SHEET INFORMATION DOES NOT CONSTITUTE A WARRANTY WITH RESPECT TO THE PRODUCTS DESCRIBED HEREIN, AND QORVO HEREBY DISCLAIMS ANY AND ALL WARRANTIES WITH RESPECT TO SUCH PRODUCTS WHETHER EXPRESS OR IMPLIED BY LAW, COURSE OF DEALING, COURSE OF PERFORMANCE, USAGE OF TRADE OR OTHERWISE, INCLUDING THE IMPLIED WARRANTIES OF MERCHANTABILITY AND FITNESS FOR A PARTICULAR PURPOSE. Without limiting the generality of the foregoing, Qorvo® products are not warranted or authorized for use as critical components in medical, life-saving, or life-sustaining applications, or other applications where a failure would reasonably be expected to cause severe personal injury or death. Applications described in the Data Sheet Information are for illustrative purposes only. Customers are responsible for validating that a particular product described in the Data Sheet Information is suitable for use in a particular application.

© 2022 Qorvo US, Inc. All rights reserved. This document is subject to copyright laws in various jurisdictions worldwide and may not be reproduced or distributed, in whole or in part, without the express written consent of Qorvo US, Inc. | QORVO® is a registered trademark of Qorvo US, Inc.