

Wide Gap Slotted Optical Switch OPB800 & OPB810 (L and W Series)

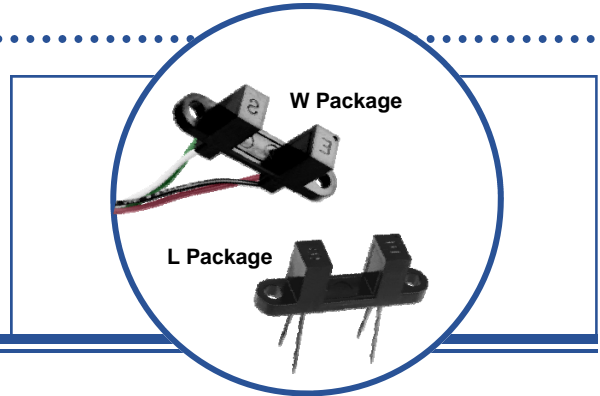

Features:

- 0.375" (9.525 mm) wide gap
- Choice of aperture size
- Choice of minimum photocurrent
- Choice of opaque or IR transmissive shells
- Available for PCBoard mounting or with 24" 26 AWG wires



Description:

The **OPB800L** series, PCBoard mounting, of wide gap switch provides the flexibility of a custom device from a standard product line, while the **OPB800W** series, remote mounted, switch offers 24" (610 mm) 26 AWG wire interconnect.

Building from a standard housing that utilizes a 0.375" (9.5 mm) wide slot, a user can specify the electrical output parameters, discrete shell material and the aperture width.

Housings are made from an opaque grade of injection-molded plastic that minimizes the assembly's sensitivity to visible and near-infrared ambient radiation. Discrete shells, which are exposed on parallel faces inside the device throat, are made of IR transmissive plastic (for applications where aperture contamination may occur) or of opaque plastic with aperture openings (for maximum protection against ambient light).

Custom electrical, wire and cabling and connectors are available. Contact your local representative or OPTEK for more information.

Applications:

- Non-contact interruptive object sensing
- Assembly line automation
- Machine automation
- Equipment security
- Machine safety

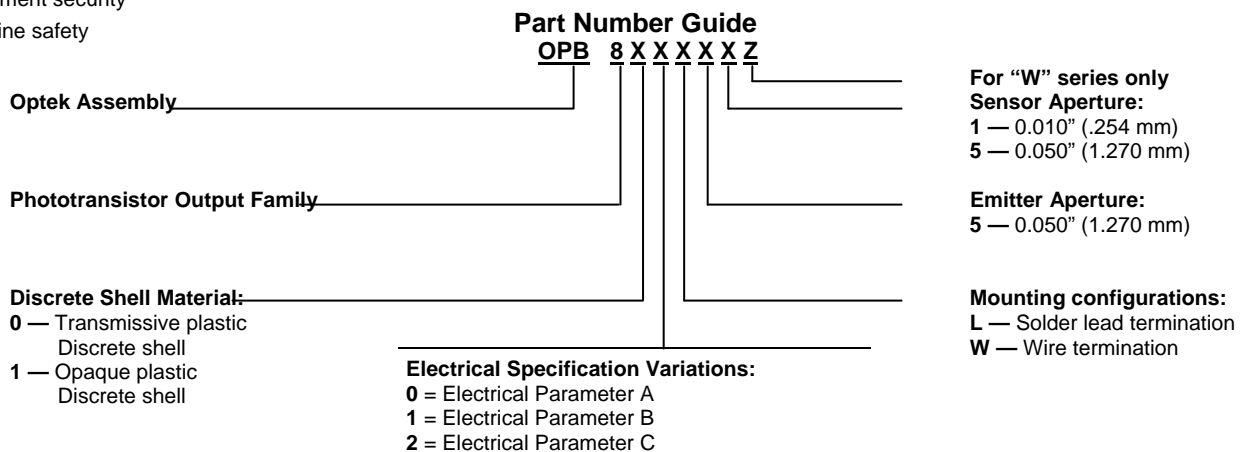

RoHS

OPTEK reserves the right to make changes at any time in order to improve design and to supply the best product possible.

Wide Gap Slotted Optical Switch OPB800 & OPB810 (L and W Series)



Absolute Maximum Ratings (T_A=25°C unless otherwise noted)

Storage and Operating Temperature L Series W Series	-40° C to +85° C -40° C to +80° C
Lead Soldering Temperature [1/16 inch (1.6mm) from the case for 5 sec. with soldering iron] ⁽²⁾	260° C

Input Diode

Forward DC Current	50 mA
Peak Forward Current (1 μs pulse width, 300 pps)	3 A
Reverse DC Voltage	2 V
Power Dissipation ⁽¹⁾	100 mW

Output Phototransistor

Collector-Emitter Voltage	30 V
Emitter-Collector Voltage	5 V
Collector DC Current	30 mA
Power Dissipation ⁽¹⁾	100 mW

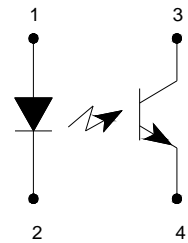
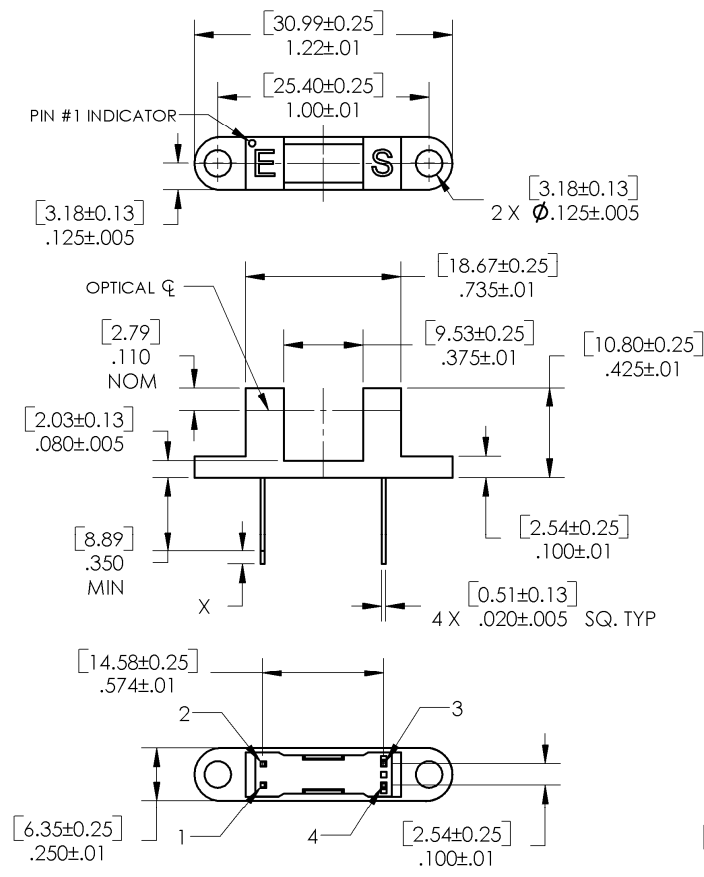

Color/Pin #	Description
Red-1	Anode
Black-2	Cathode
White-3	Collector
Green-4	Emitter

Wired (W) Version

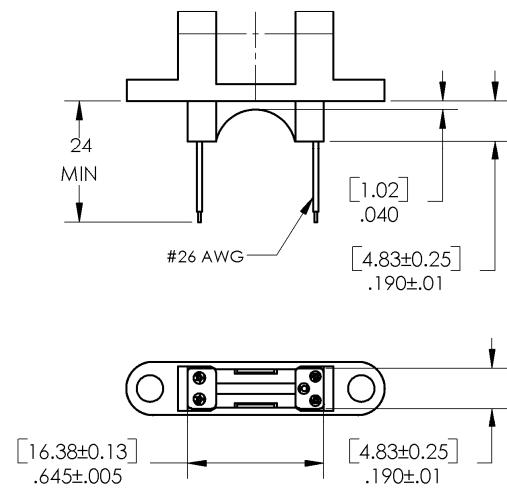

[MILLIMETERS]
DIMENSIONS ARE IN: INCHES

OPTEK reserves the right to make changes at any time in order to improve design and to supply the best product possible.

Wide Gap Slotted Optical Switch

OPB800 & OPB810 (L and W Series)



Electrical Characteristics ($T_A = 25^\circ\text{C}$ unless otherwise noted)

SYMBOL	PARAMETER	MIN	TYP	MAX	UNITS	TEST CONDITIONS
--------	-----------	-----	-----	-----	-------	-----------------

Input Diode

V_F	Forward Voltage	-	-	1.7	V	$I_F = 20\text{ mA}$
I_R	Reverse Current	-	-	100	μA	$V_R = 2\text{ V}$

Output Phototransistor

$V_{(BR)CEO}$	Collector-Emitter Breakdown Voltage	30	-	-	V	$I_C = 1\text{ mA}$
$V_{(BR)ECO}$	Emitter-Collector Breakdown Voltage	5	-	-	V	$I_E = 100\ \mu\text{A}$
I_{CEO}	Collector-Emitter Dark Current	-	-	100	nA	$V_{CE} = 10\text{ V}$

Combined

$V_{CE(SAT)}$	Collector-Emitter Saturation Voltage					
	Parameter A (OPB800,OPB810)	-	-	0.4	V	$I_C = 250\ \mu\text{A}, I_F = 20\text{ mA}$
	Parameter B (OPB801,OPB811)	-	-	0.4	V	$I_C = 500\ \mu\text{A}, I_F = 10\text{ mA}$
	Parameter C (OPB802,OPB812)	-	-	0.6	V	$I_C = 1800\ \mu\text{A}, I_F = 20\text{ mA}$
$I_{C(ON)}$	On-State Collector Current					
	Parameter A (OPB800,OPB810)	0.625	-	-	mA	$V_{CE} = 10\text{ V}, I_F = 20\text{ mA}$
	Parameter B (OPB801,OPB811)	1.25	-	-		$V_{CE} = 5\text{ V}, I_F = 10\text{ mA}$
Parameter C (OPB802,OPB812)	2.25	-	-	$V_{CE} = 0.6\text{ V}, I_F = 20\text{ mA}$		

Notes:

- (1) Derate linearly $1.67\text{ mW}/^\circ\text{C}$ above 25°C .
- (2) RMA flux is recommended. Duration can be extended to 10 seconds maximum when flow soldering.
- (3) All parameters tested using pulse technique.
- (4) Methanol or isopropanol are recommended as cleaning agents. Plastic housing is soluble in chlorinated hydrocarbons and ketones.
- (5) The W Series includes wire terminations of 24" (610 mm) 7-strand, 26 AWG UL insulated wire on each terminal. Each device incorporates a wire strain relief at the housing surface. The insulation functions and colors are: anode (red), cathode (black), phototransistor collector (white) and phototransistor emitter (green).

OPTEK reserves the right to make changes at any time in order to improve design and to supply the best product possible.

OPB800_51 - Flag Next to Emitter

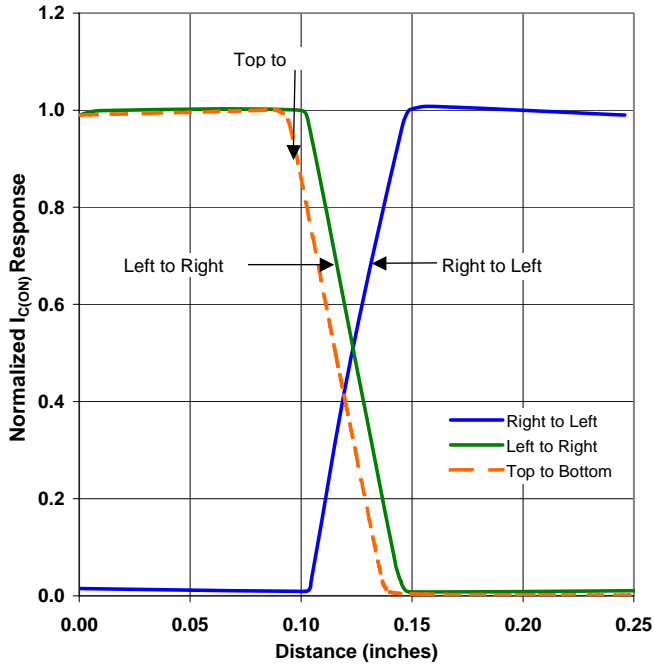

OPB800_51 - Flag Next to Sensor

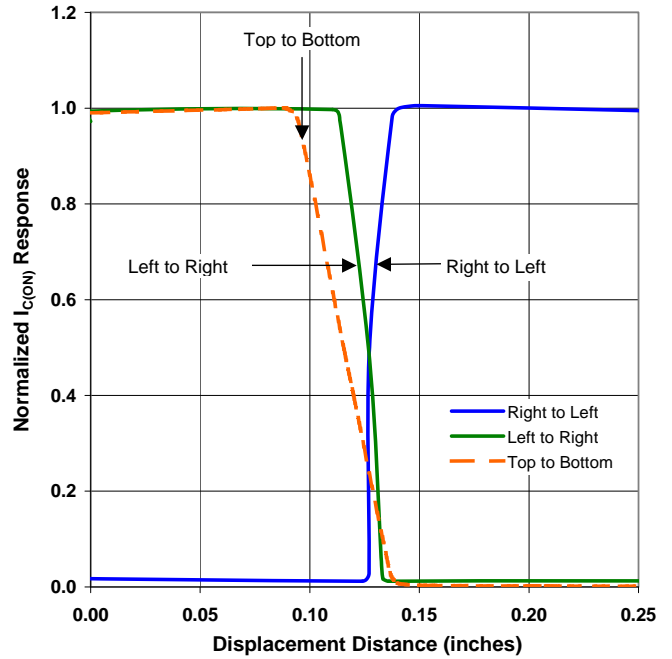

OPB800_51 - Flag in Middle of Slot

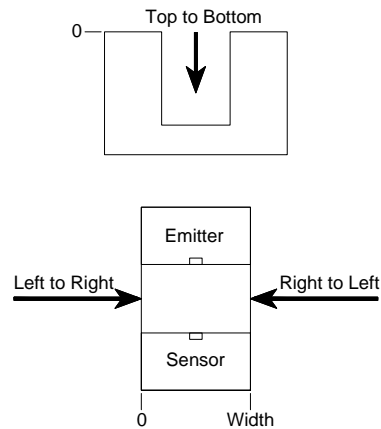
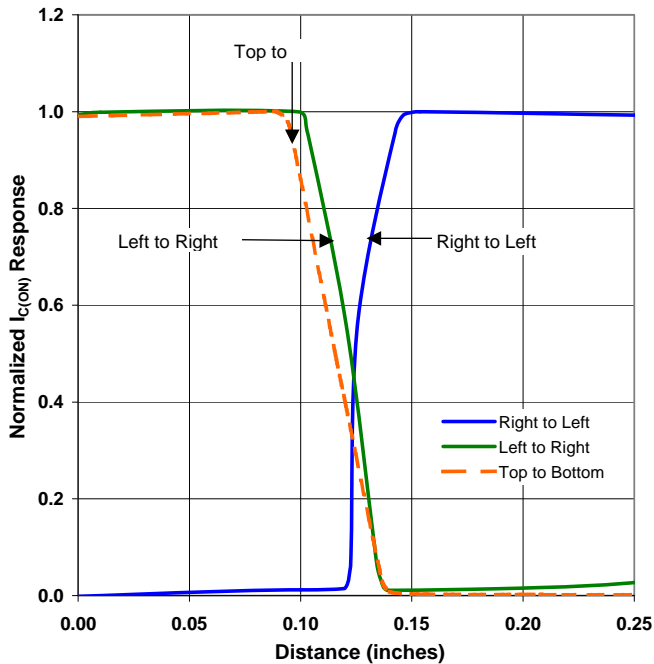

OPTEK reserves the right to make changes at any time in order to improve design and to supply the best product possible.

OPB800_55 - Flag Next to Emitter

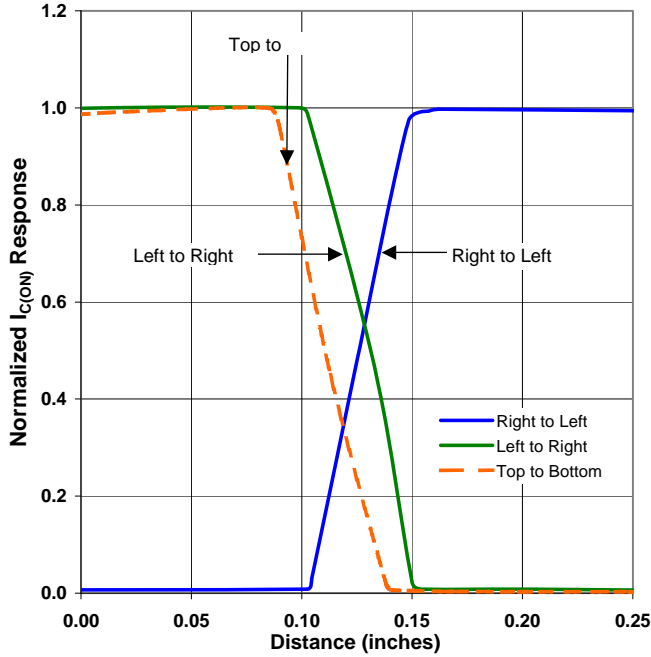

OPB800_55 - Flag Next to Sensor

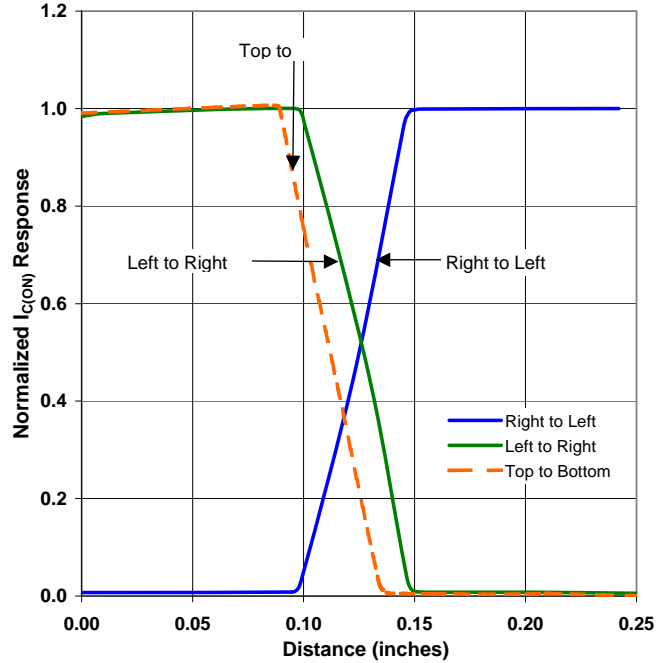

OPB800_55 - Flag in Middle of Slot

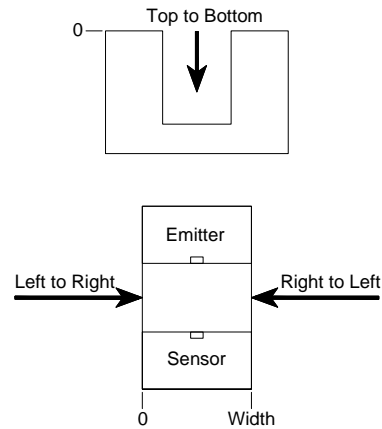
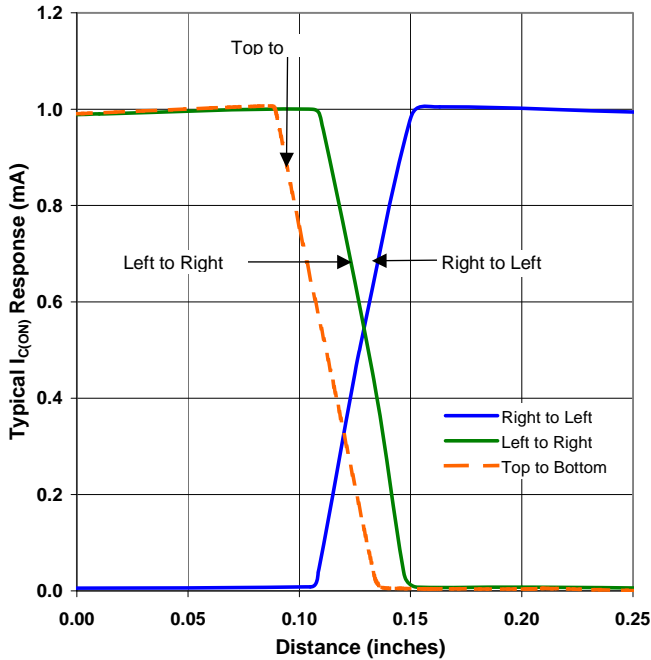

OPTEK reserves the right to make changes at any time in order to improve design and to supply the best product possible.

Mouser Electronics

Authorized Distributor

Click to View Pricing, Inventory, Delivery & Lifecycle Information:

Optek:

[OPB810L51](#) [OPB800W51](#) [OPB800W55](#) [OPB801W55](#) [OPB802W55](#) [OPB810W51](#) [OPB811W55](#) [OPB800W51Z](#)
[OPB800W55Z](#) [OPB801W55Z](#) [OPB802W55Z](#) [OPB810W51Z](#) [OPB810W55Z](#) [OPB811W55Z](#) [OPB812W55Z](#)
[OPB800L51](#) [OPB800L55](#) [OPB810L55](#) [OPB801L55](#) [OPB812L55](#) [OPB811L55](#) [OPB802L55](#)