

### Features

- Ballast control and half bridge driver in one IC
- Programmable preheat frequency
- Programmable preheat time
- Internal ignition ramp
- Programmable over-current threshold
- Programmable run frequency
- Programmable dead time
- DC bus under-voltage reset
- Shutdown pin with hysteresis
- Internal 15.6V zener clamp diode on Vcc
- Micropower startup (150  $\mu$ A)
- Latch immunity and ESD protection

### Description

The IR2156 incorporates a high voltage half-bridge gate driver with a programmable oscillator and state diagram to form a complete ballast control IC. The IR2156 features include programmable preheat and run frequencies, programmable preheat time, programmable dead-time, and programmable over-current protection. Comprehensive protection features such as protection from failure of a lamp to strike, filament failures, as well as an automatic restart function, have been included in the design.

### Packages

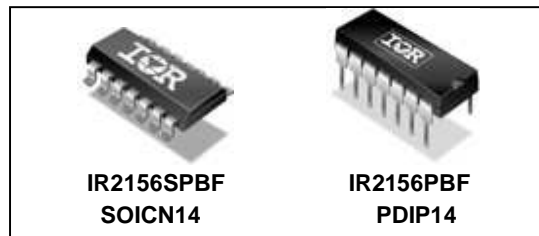

### Application Diagram

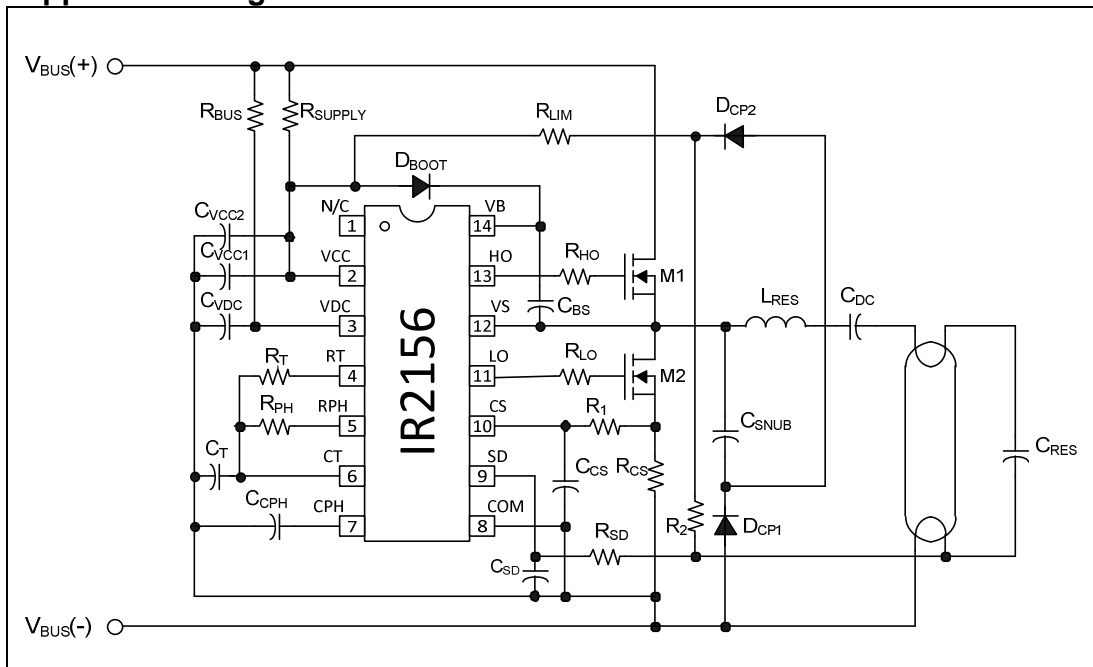

## Absolute Maximum Ratings

Absolute Maximum Ratings indicate sustained limits beyond which damage to the device may occur. All voltage parameters are absolute voltages referenced to COM, all currents are defined positive into any lead. The Thermal Resistance and Power Dissipation ratings are measured under board mounted and still air conditions.

Symbol	Definition	Min.	Max.	Units	
VB	High side floating supply voltage	-0.3	625	V	
VS	High side floating supply offset voltage	VB - 25	VB + 0.3		
VHO	High side floating output voltage	VS - 0.3	VB + 0.3		
VLO	Low side output voltage	-0.3	VCC + 0.3		
IOMAX	Maximum allowable output current (HO, LO) due to external power transistor miller effect	-500	500	mA	
VDC	VDC pin voltage	-0.3	VCC+0.3	V	
VCT	CT pin voltage	-0.3	VCC+0.3		
VCPH	CPH pin voltage	-0.3	VCC+0.3		
ICPH	CPH pin current	-5	5	mA	
IRPH	RPH pin current	-5	5		
VRPH	RPH pin voltage	-0.3	VCC+0.3	V	
IRT	RT pin current	-5	5	mA	
VRT	RT pin voltage	-0.3	VCC+0.3	V	
VCS	Current sense pin voltage	-0.3	5.5		
ICS	Current sense pin current	-5	5	mA	
ISD	Shutdown pin current	-5	5		
ICC	Supply current (Note 1)	-20	20		
dV/dt	Allowable offset voltage slew rate	-50	50	V/ns	
PD	Package power dissipation @ $T_A \leq +25^\circ\text{C}$ $PD = (T_{JMAX} - T_A) / R_{\theta JA}$	(14-Pin DIP)	---	1.80	W
		(14-Pin SOIC)	---	1.40	
R $\theta$ JA	Thermal resistance, junction to ambient	(14-Pin DIP)	---	70	$^\circ\text{C/W}$
		(14-Pin SOIC)	---	82	
TJ	Junction temperature	-55	150	$^\circ\text{C}$	
TS	Storage temperature	-55	150		
TL	Lead temperature (soldering, 10 seconds)	---	300		

Note 1: This IC contains a zener clamp structure between the chip VCC and COM which has a nominal breakdown voltage of 15.6V. Please note that this supply pin should not be driven by a DC, low impedance power source greater than the VCLAMP specified in the Electrical Characteristics section.

## Recommended Operating Conditions

For proper operation the device should be used within the recommended conditions.

Symbol	Definition	Min.	Max.	Units
VBS	High side floating supply voltage	VBSUV+	VCLAMP	V
VS	Steady state high side floating supply offset voltage	-1	600	
VCC	Supply voltage	VCCUV+	VCLAMP	
ICC	Supply current	Note 2	10	mA
CT	CT lead capacitance	220	---	pF
ISD	Shutdown lead current	-1	1	mA
ICS	Current sense pin current	-1	1	
TJ	Junction temperature	-25	125	°C

Note 2: Enough current should be supplied into the VCC pin to keep the internal 15.6V zener clamp diode on this pin regulating at its voltage, VCLAMP.

## Electrical Characteristics

VCC = VBS = VBIAS = 14V +/- 0.25V, VVDC=Open, RT=40KΩ, RPH=100KΩ, CT=470 pF, VCPH=0.0V, VSD=0.0V, VCS=0.0V, CLO=CHO=1000 pF, TA=25C unless otherwise specified.

Symbol	Definition	Min	Typ	Max	Units	Test Conditions
<b>Supply Characteristics</b>						
VCCUV+	VCC supply undervoltage positive going threshold	10.5	11.5	12.5	V	VCC rising from 0V
VCCUV-	VCC supply undervoltage negative going threshold	8.5	9.5	10.5		VCC falling from 14V
VUVHYS	VCC supply undervoltage lockout hysteresis	1.5	2.0	3.0		
IQCCUV	UVLO mode quiescent current	50	120	200	μA	VCC=11V
IQCCFLT	Fault-mode quiescent current	---	200	470		SD = 5.1V, or CS = 1.3V
IQCC	Quiescent VCC supply current	---	1.0	1.5	mA	CT connected to COM, VCC = 14V, RT = 15kΩ
ICC40k	VCC supply current, f = 40kHz	1.3	1.5	1.7		VCPH=12V, VVDC=12V
VCLAMP	VCC zener clamp voltage	14.5	15.6	16.5	V	ICC = 5mA
<b>Floating Supply Characteristics</b>						
IQBS0	Quiescent VBS supply current	-5	0	5	μA	VHO = VS (CT=0V)
IQBS1	Quiescent VBS supply current	---	30	50		VHO = VB (CT=14V)
ILK	Offset supply leakage current	---	---	50	μA	VB = VS = 600V

## Electrical Characteristics

VCC = VBS = VBIAS = 14V +/- 0.25V, VVDC=Open, RT=40KΩ, RPH=100KΩ, CT=470 pF, VCPH=0.0V, VSD=0.0V, VCS=0.0V, CLO=CHO=1000 pF, TA=25C unless otherwise specified.

Symbol	Definition	Min	Typ	Max	Units	Test Conditions
<b>Oscillator, Ballast Control, I/O Characteristics</b>						
f <sub>OSCRUN</sub>	Oscillator frequency during RUN mode	36.0	40.0	44.0	kHz	V <sub>VDC</sub> =14V, V <sub>CPH</sub> =Open
f <sub>OSCPH</sub>	Oscillator frequency during PH mode	49.0	55.0	60.0		V <sub>VDC</sub> =14V, V <sub>CPH</sub> =COM
d	Oscillator duty cycle	---	50	---	%	
VCT+	Upper CT ramp voltage threshold	---	8.3	---	V	V <sub>CC</sub> =14V SD>5.1V or CS>1.3V
VCT-	Lower CT ramp voltage threshold	---	4.8	---		
VCTFLT	Fault-mode CT pin voltage	---	0	---		
t <sub>DLO</sub>	LO output deadtime	---	2.0	---	μsec	
t <sub>DHO</sub>	HO output deadtime	---	2.0	---		
RDT	Internal deadtime resistor	---	3	---	kΩ	
<b>Preheat Characteristics</b>						
I <sub>CPH</sub>	CPH pin charging current	3.6	4.3	5.2	μA	CT=10V, VDC=5V, VCPH=0V
V <sub>CPHFLT</sub>	Fault-mode CPH pin voltage	---	0	---	mV	SD>5.1V or CS>1.3V
<b>RPH Characteristics</b>						
I <sub>RPHLK</sub>	Open circuit RPH pin leakage current	---	0.1	---	μA	CT=10V
V <sub>RPHFLT</sub>	Fault-mode RPH pin voltage	---	0	---	mV	SD>5.1V or CS>1.3V
<b>RT Characteristics</b>						
I <sub>RTLK</sub>	Open circuit RT pin leakage current	---	0.1	---	μA	CT=10V
V <sub>RTFLT</sub>	Fault-mode RT pin voltage	---	0	---	mV	SD>5.1V or CS>1.3V
<b>Protection Circuitry Characteristics</b>						
V <sub>SDTH+</sub>	Rising shutdown pin threshold voltage	---	5.1	---	V	
V <sub>SDHYS</sub>	SD pin Reset threshold voltage	---	450	---	mV	
V <sub>CSTH+</sub>	Over-current sense threshold voltage	1.1	1.25	1.44	V	
t <sub>CS</sub>	Over-current sense propagation delay	---	160	---	nsec	Delay from CS to LO
V <sub>CSPW</sub>	Over-current sense minimum pulse width	---	135	---		VCS pulse amplitude = V <sub>CSTH</sub> + 100mV
R <sub>VDC</sub>	DC bus sensing resistor	7.5	10.0	14.0	kΩ	V <sub>CPH</sub> >12V, VDC=7V, CT=0
V <sub>CPH-VDC</sub>	CPH to VDC offset voltage	10.3	10.9	11.4	V	V <sub>CPH</sub> open, VDC=0V

## Electrical Characteristics

VCC = VBS = VBIAS = 14V +/- 0.25V, VVDC=Open, RT=39KΩ, RPH=100KΩ, CT=470 pF, VCPH=0.0V, VSD=0.0V, VCS=0.0V, CLO=CHO=1000 pF, TA=25C unless otherwise specified.

Symbol	Definition	Min	Typ	Max	Units	Test Conditions
<b>Gate Driver Output Characteristics</b>						
VOL	Low-level output voltage	---	COM	---	V	IO = 0
VOH	High-level output voltage	---	VCC	---		IO = 0
t <sub>r</sub>	Turn-on rise time	---	110	150	nsec	
t <sub>f</sub>	Turn-off fall time	---	55	100		

## Block Diagram

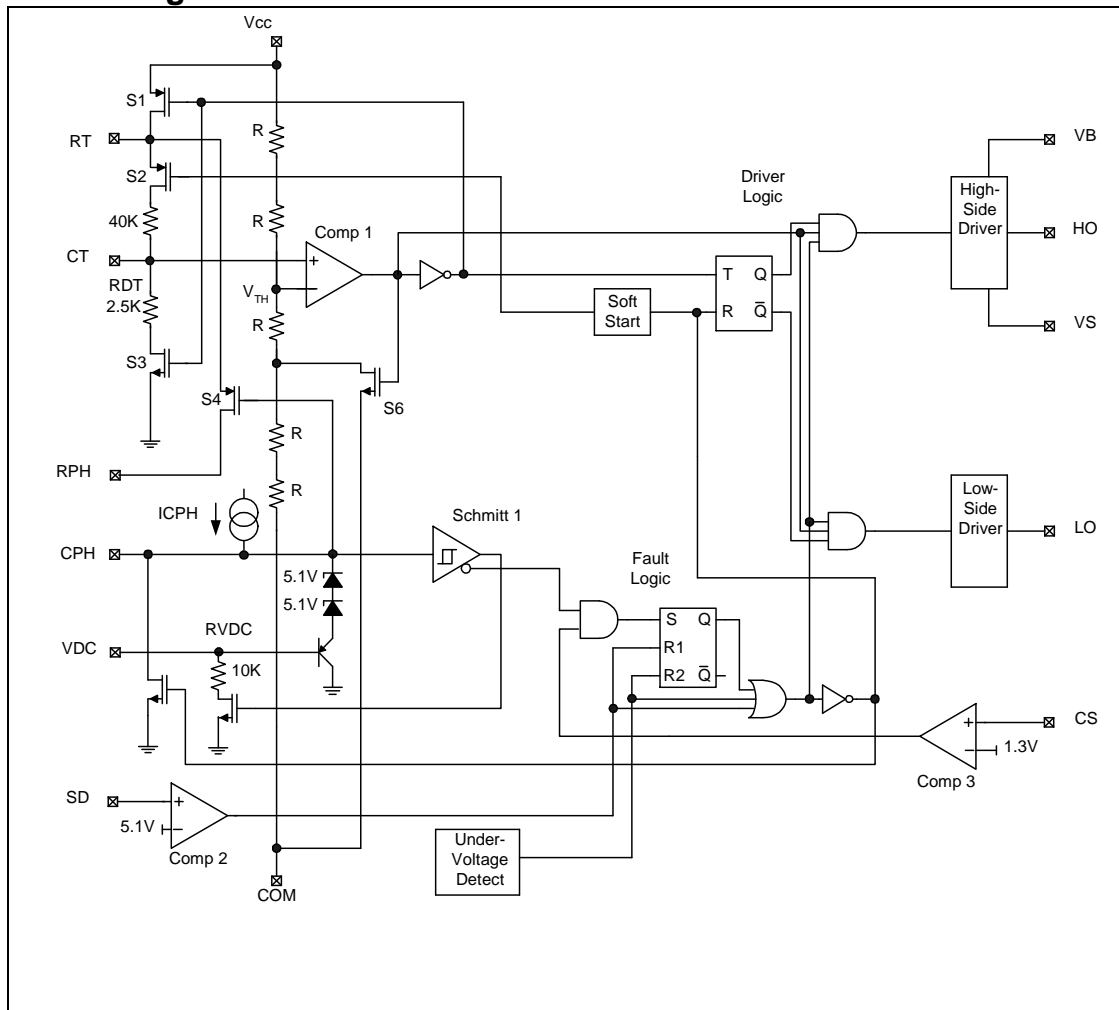

## Pin Assignments & Definitions

Pin Assignments		Pin #	Symbol	Description
NC	1	14	VB	No Connect
VCC	2	13	HO	Logic & Low-Side Gate Driver Supply
VDC	3	12	VS	IC Start-up and DC Bus Sensing Input
RT	4	11	LO	Minimum Frequency Timing Resistor
RPH	5	10	CS	Preheat Frequency Timing Resistor
CT	6	9	SD	Oscillator Timing Capacitor
CPH	7	8	COM	Preheat Timing Capacitor
				IC Power & Signal Ground
				Shutdown Input
				Current Sensing Input
				Low-Side Gate Driver Output
				High-Side Floating Return
				High-Side Gate Driver Output
				High-Side Gate Driver Floating Supply

## State Diagram

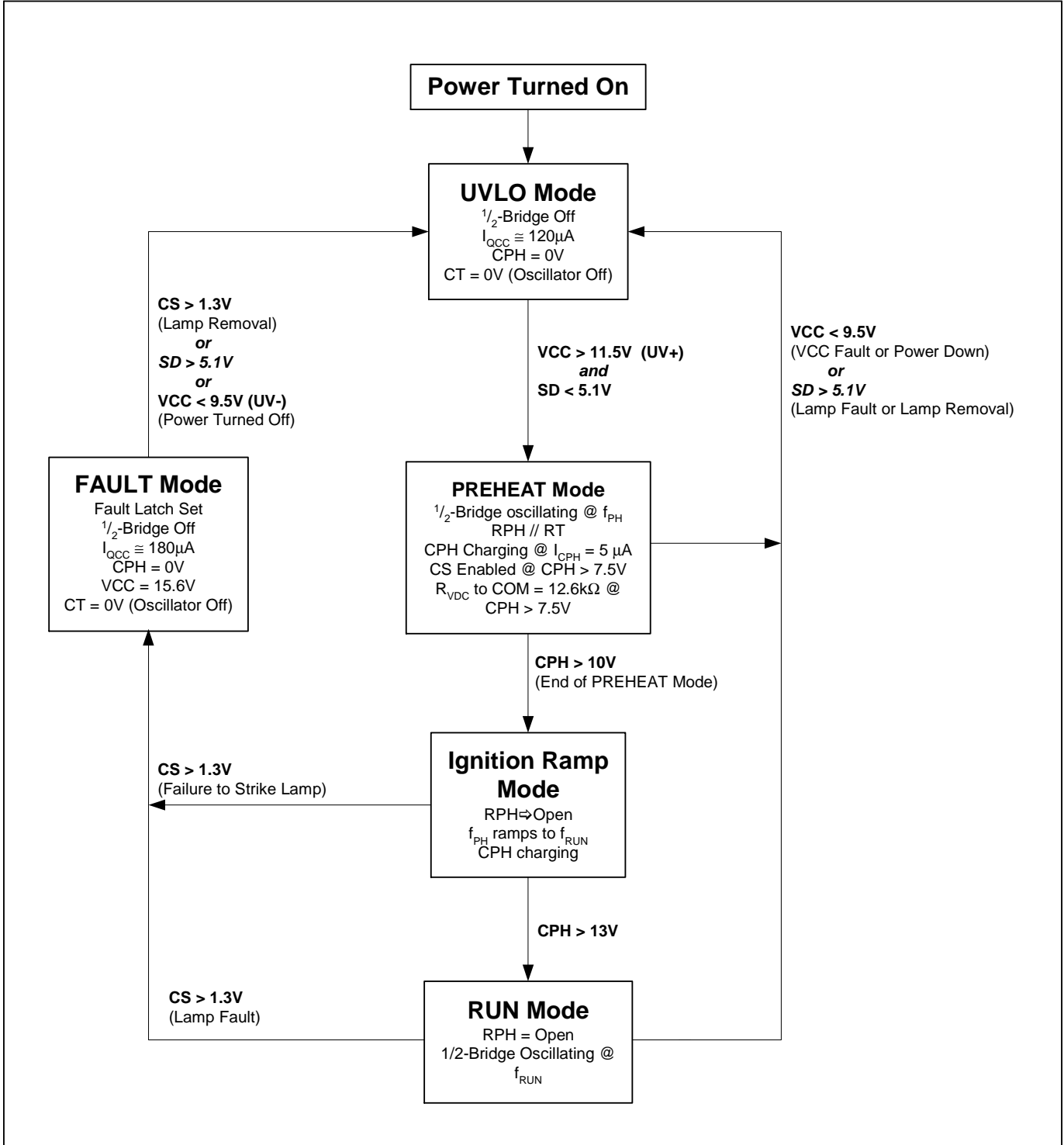

## TIMING DIAGRAMS NORMAL OPERATION

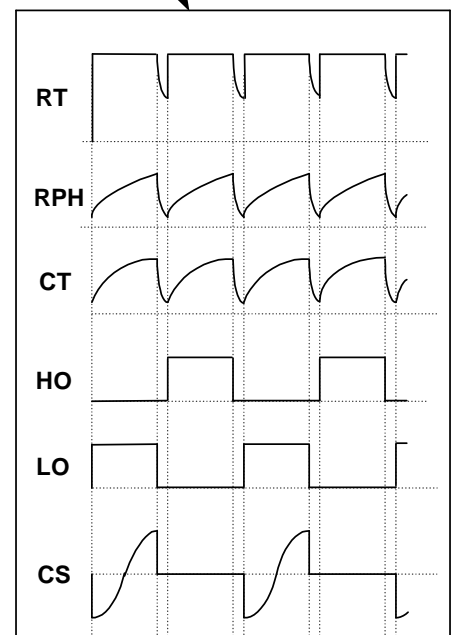
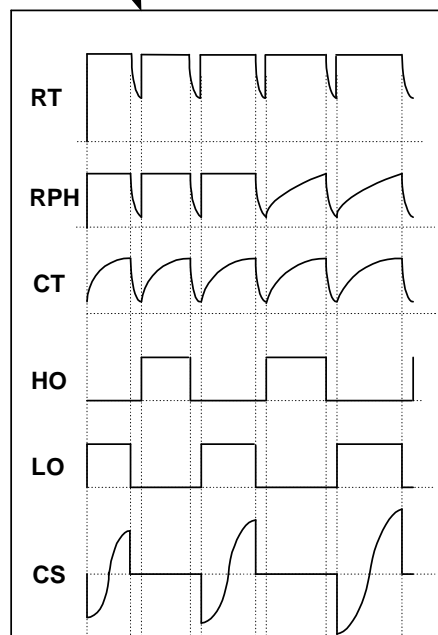
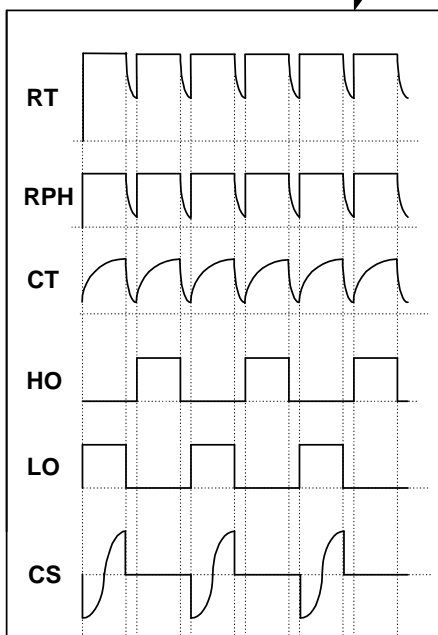
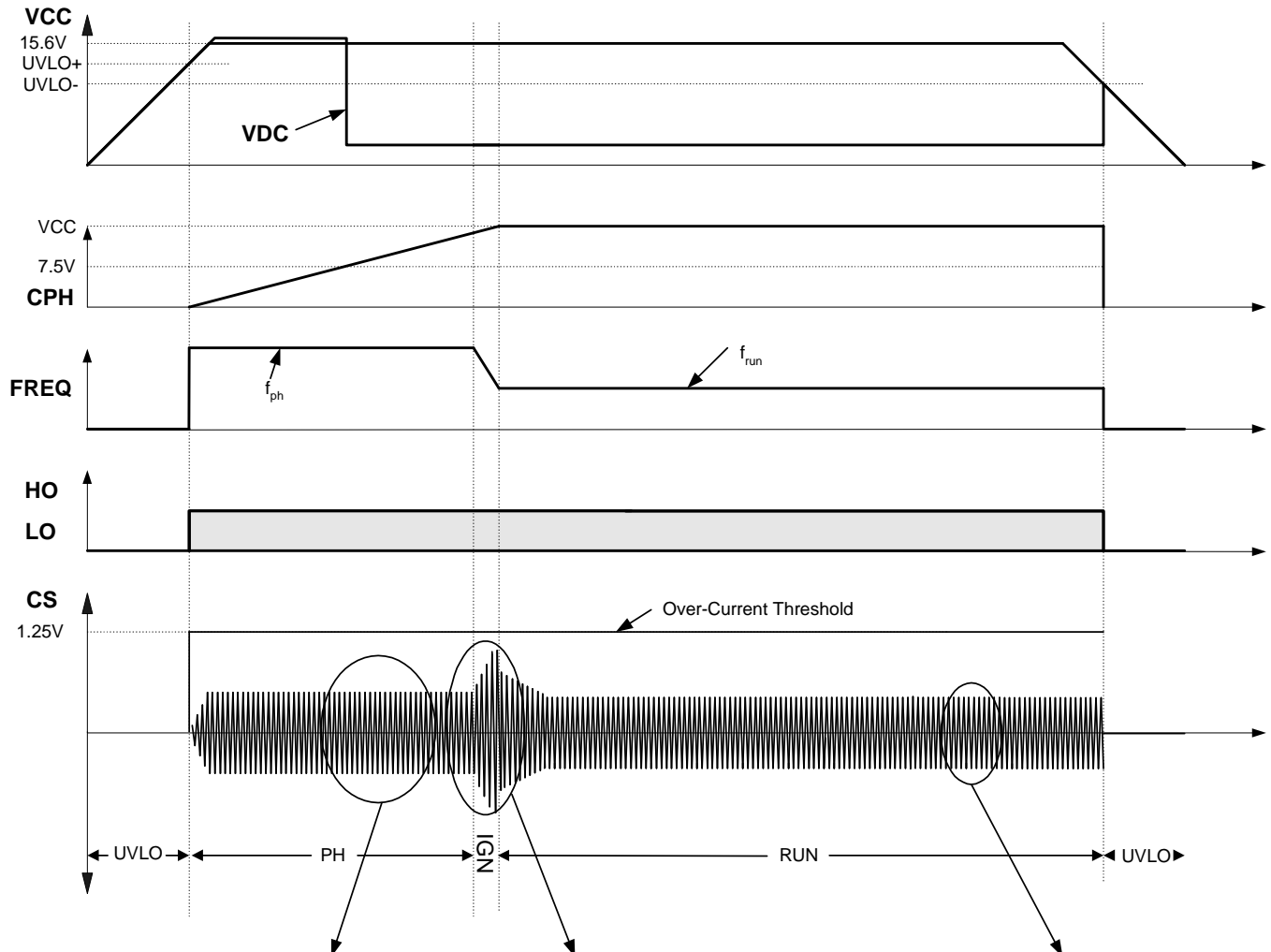



## TIMING DIAGRAMS FAULT CONDITION

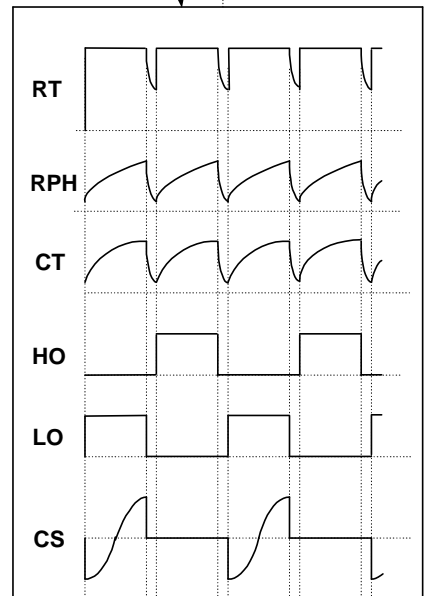
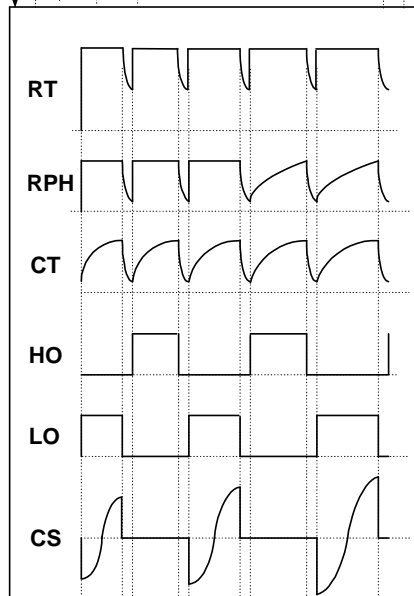
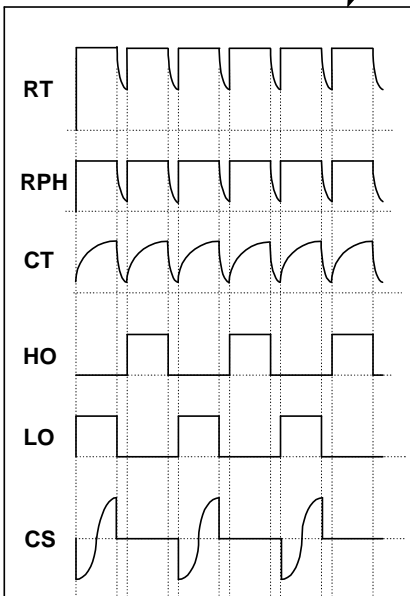
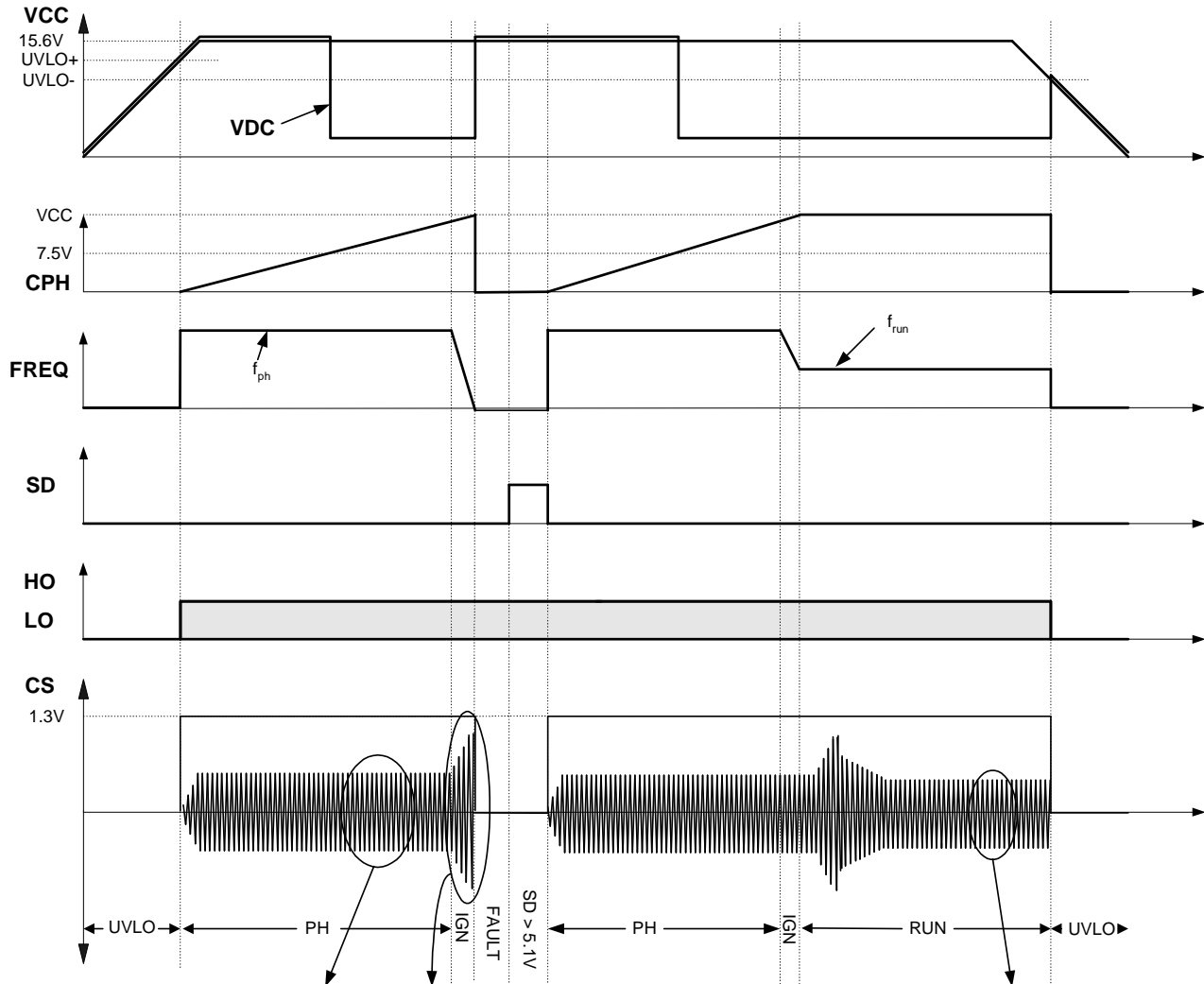

## Characterization Data

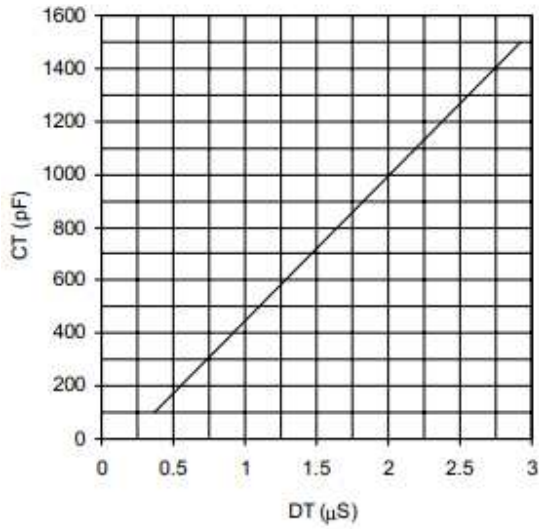

Graph 1. CT vs Dead Time (IR2156)

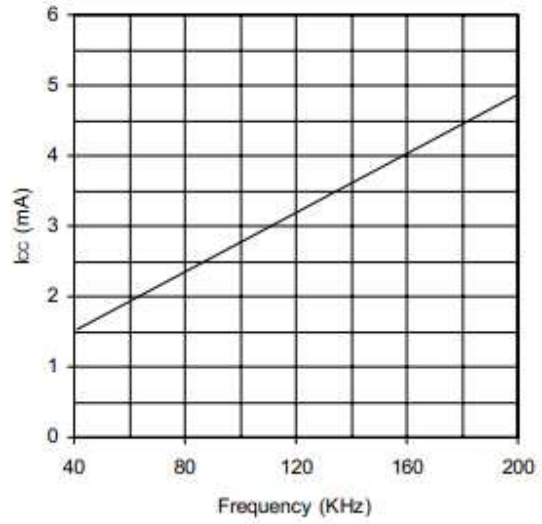

Graph 2. I<sub>CC</sub> vs Frequency (IR2156)

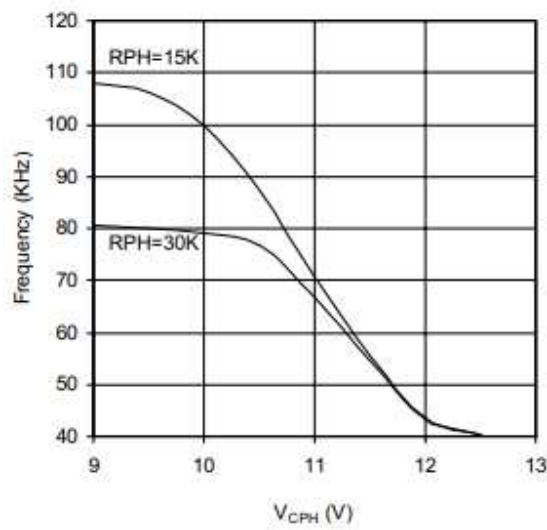

Graph 3. Frequency vs V<sub>CPH</sub> (IR2156)

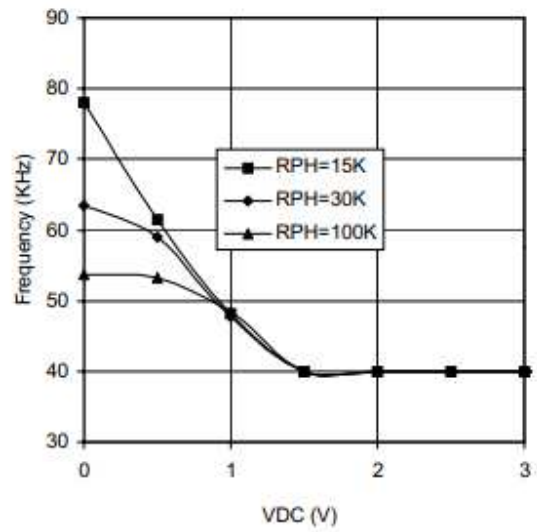

Graph 4. Frequency vs V<sub>DC</sub> (IR2156)

## Characterization Data

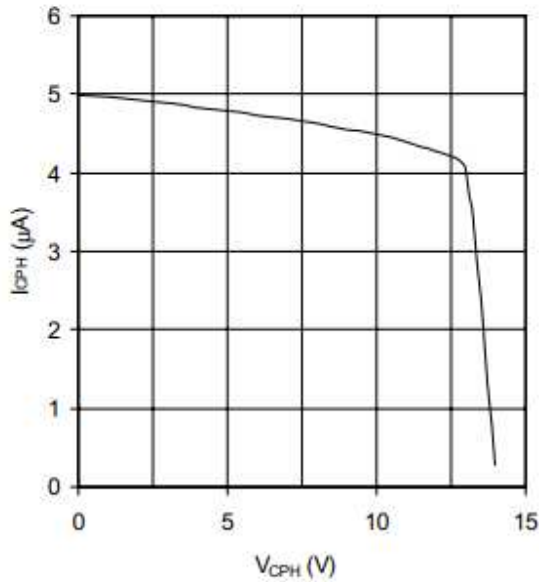

Graph 5. I<sub>CPH</sub> vs V<sub>CPH</sub> (IR2156)

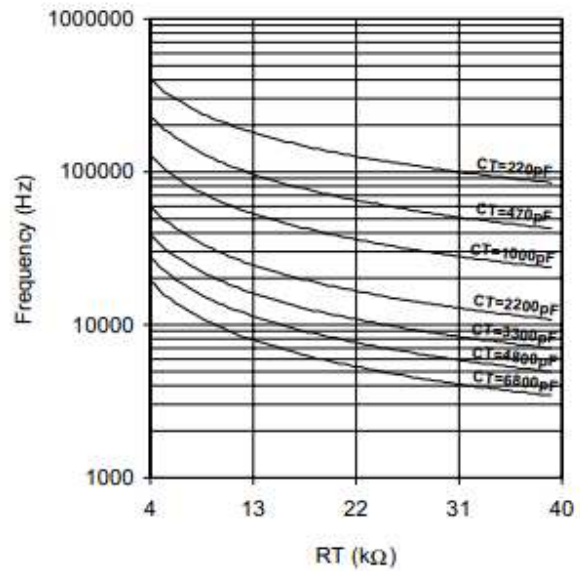

Graph 6. Frequency vs RT (IR2156)

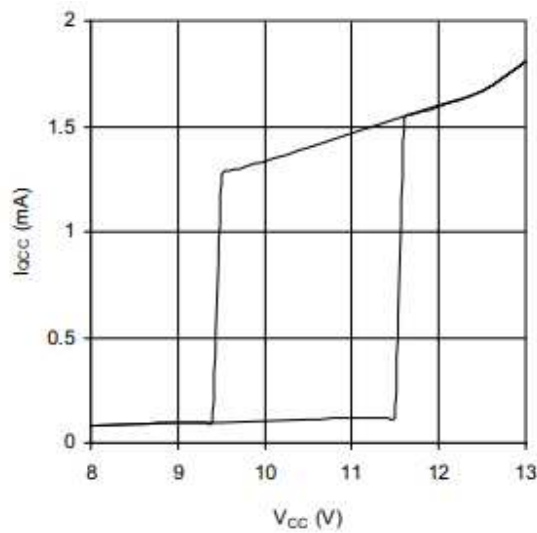

Graph 7. I<sub>QCC</sub> vs V<sub>CC</sub> (IR2156)  
 UVLO Hysteresis

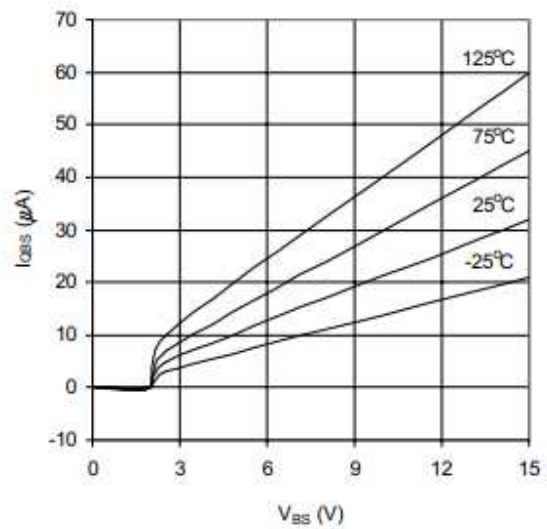

Graph 8. I<sub>QBS</sub> vs V<sub>CC</sub> vs Temp (IR2156)

## Characterization Data

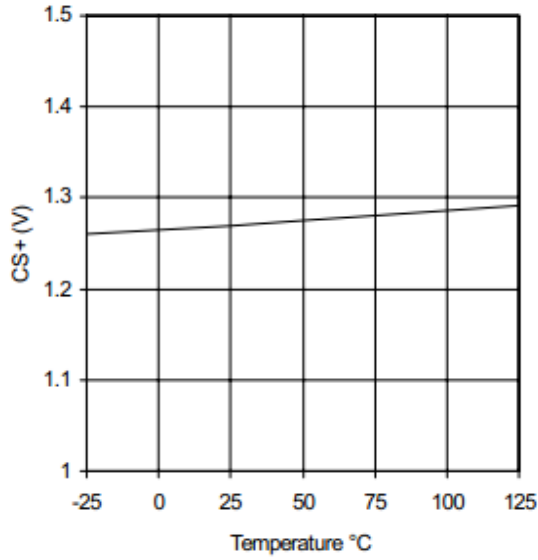

Graph 9. VCSTH+ vs Temperature (IR2156)

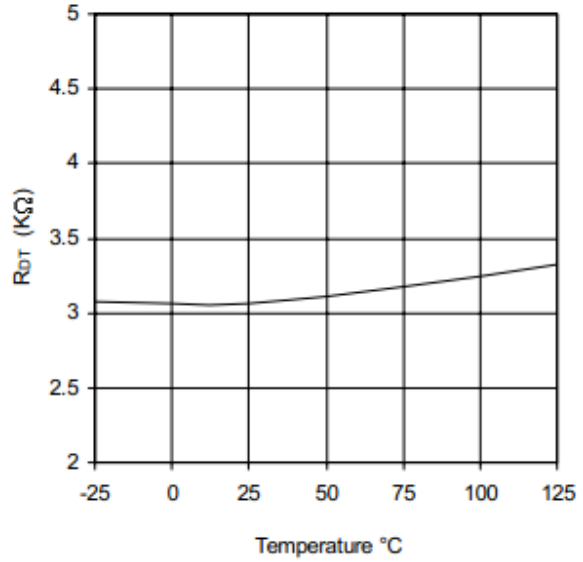

Graph 10. RDT vs Temperature (IR2156)

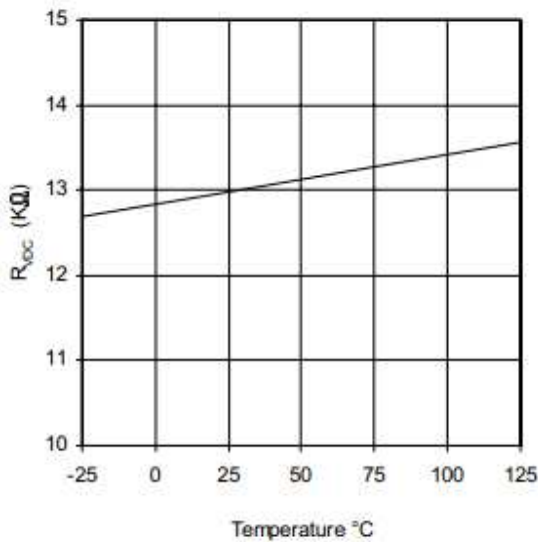

Graph 11. RVDC+ vs Temperature (IR2156)

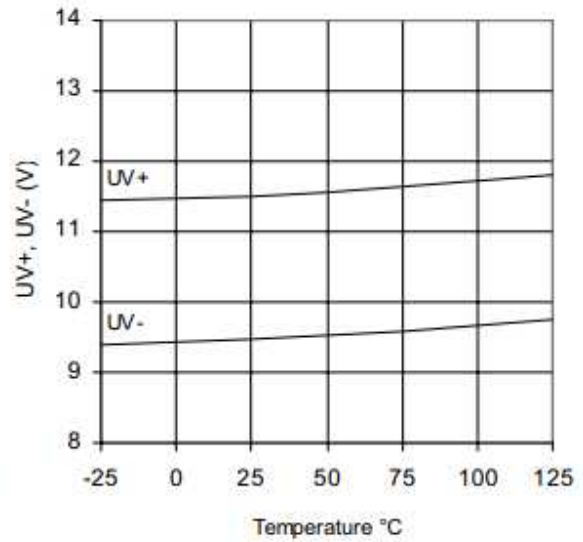

Graph 12. UV+, UV- vs Temperature (IR2156)

## Characterization Data

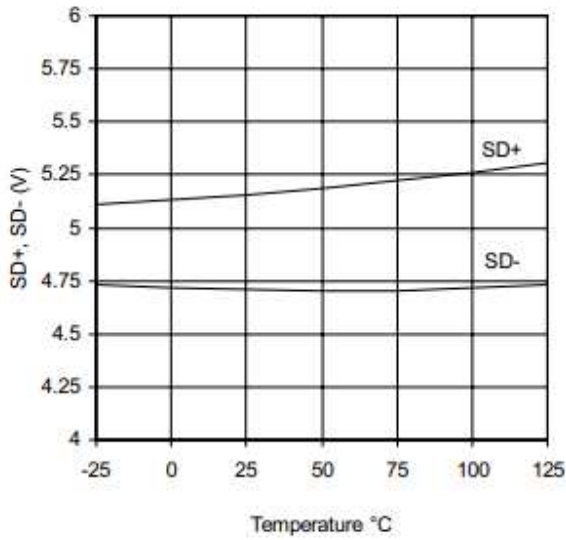

Graph 13. SD+, SD- vs Temperature (IR2156)

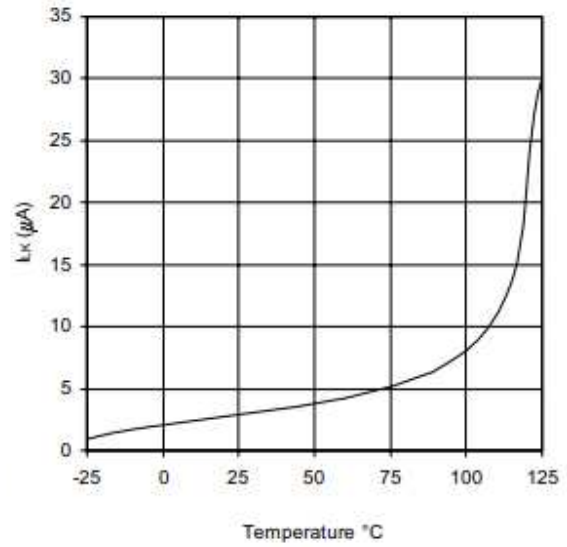

Graph 14.  $I_{LK}$  vs Temperature (IR2156)

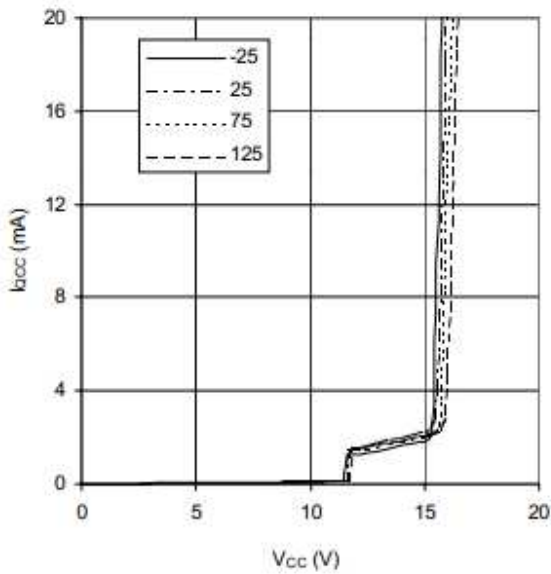

Graph 15.  $I_{QCC}$  vs  $V_{CC}$  vs Temperature (IR2156)

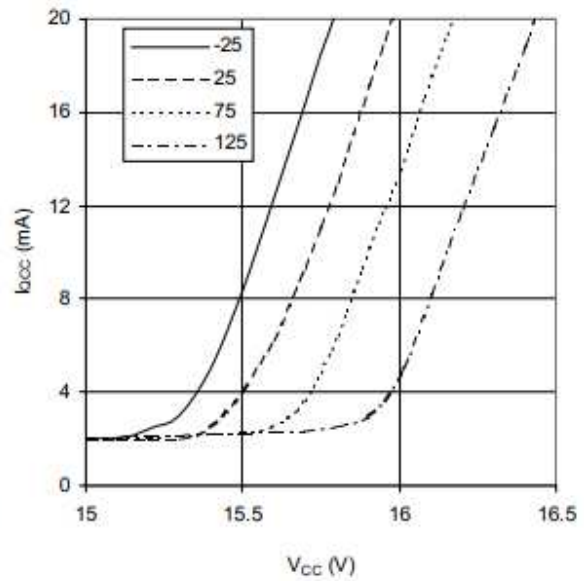

Graph 16.  $I_{QCC}$  vs  $V_{CC}$  vs Temperature (IR2156)  
 Internal Zener Diode Curve

## Characterization Data

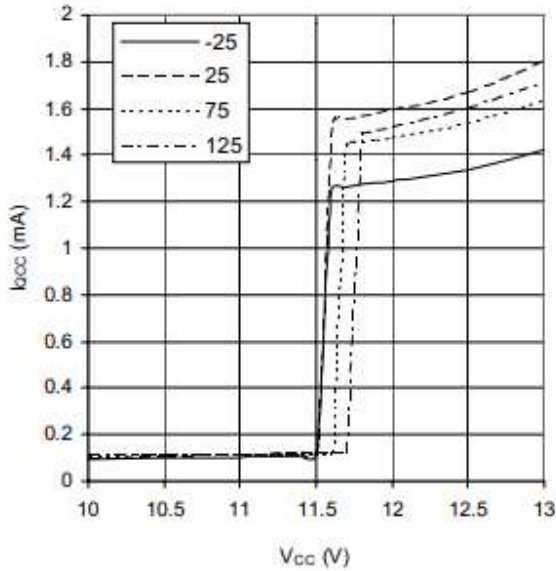

Graph 17.  $I_{QCC}$  vs  $V_{CC}$  vs Temperature (IR2156)  
 $V_{CCUV+}$

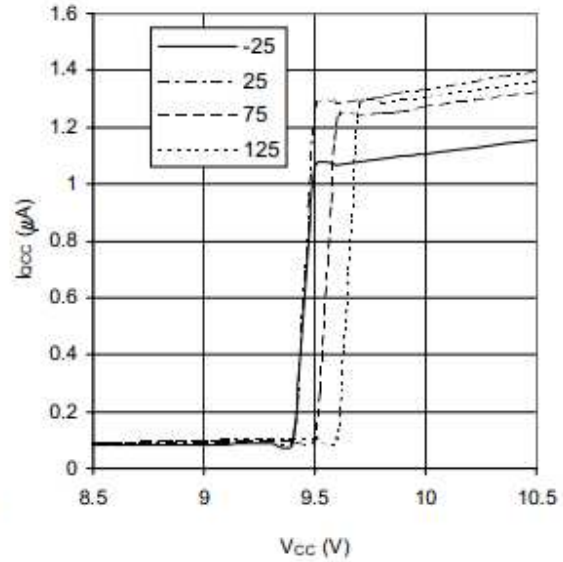

Graph 18.  $I_{QCC}$  vs  $V_{CC}$  vs Temperature (IR2156)  
 $V_{CCUV-}$

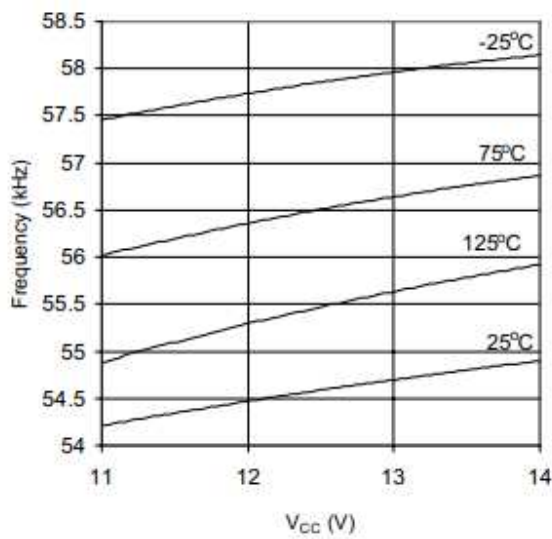

Graph 19.  $F_{OSC}$  vs  $V_{CC}$  vs Temperature (IR2156)  
 $V_{CPH} = 0V$

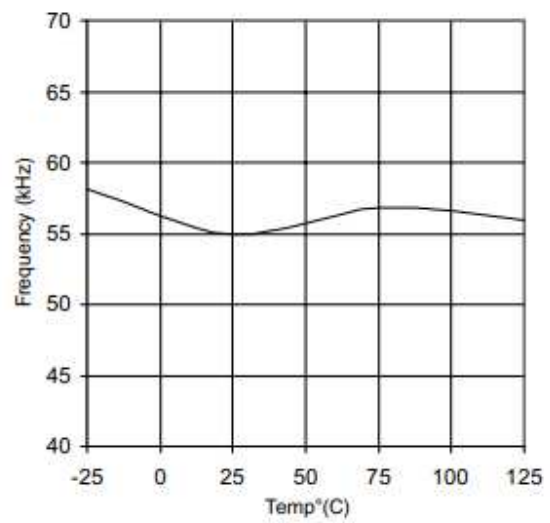

Graph 20.  $F_{OSC}$  vs Temperature (IR2156)  
 $V_{CPH} = 0V$

## Characterization Data

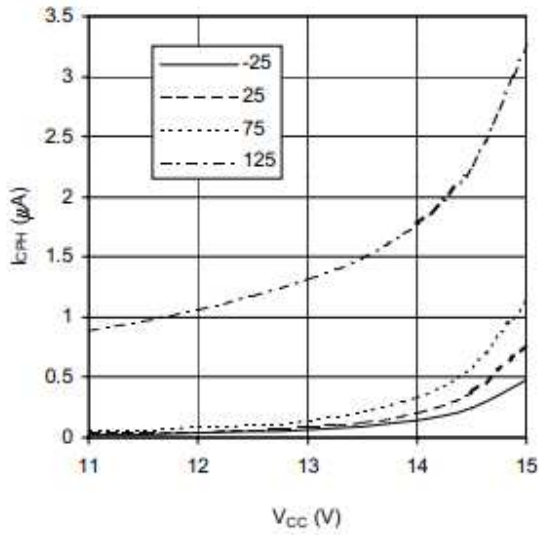

Graph 21.  $I_{CPH}$  vs  $V_{CC}$  vs Temperature (IR2156)  
 $V_{CPH} = V_{CC}$

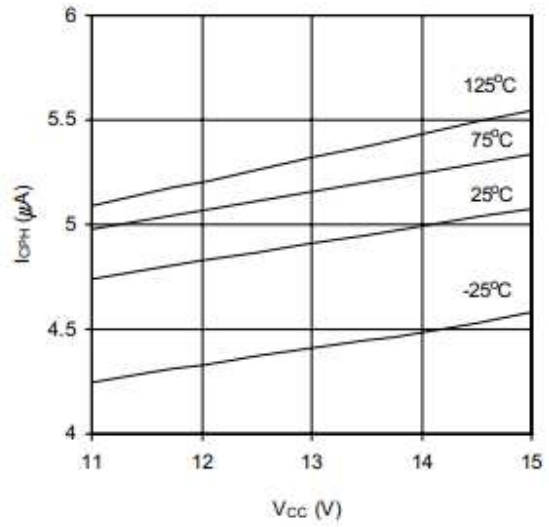

Graph 22.  $I_{CPH}$  vs  $V_{CC}$  vs Temperature (IR2156)  
 $V_{CPH} = 0V$

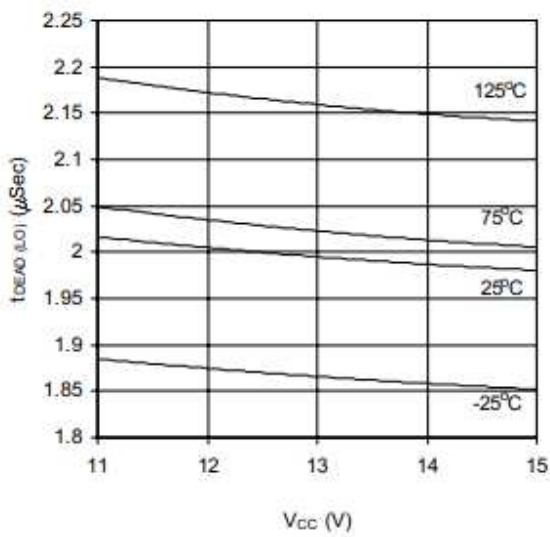

Graph 23.  $t_{DEAD} (LO)$  vs  $V_{CC}$  vs Temperature (IR2156)  
 $C_T = 1nF$

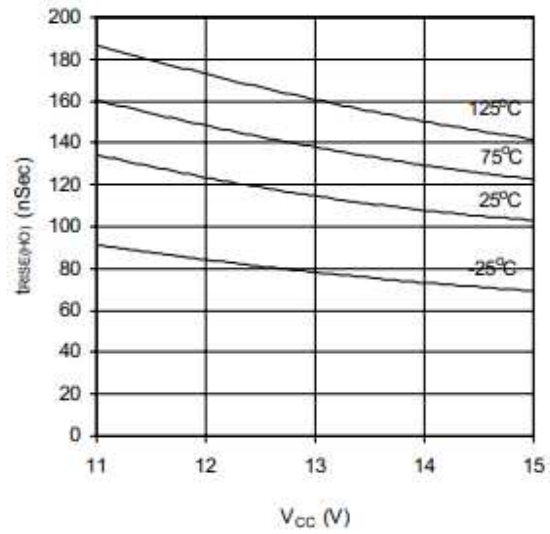

Graph 24.  $t_{RISE} (HO)$  vs  $V_{CC}$  vs Temperature (IR2156)

## Characterization Data

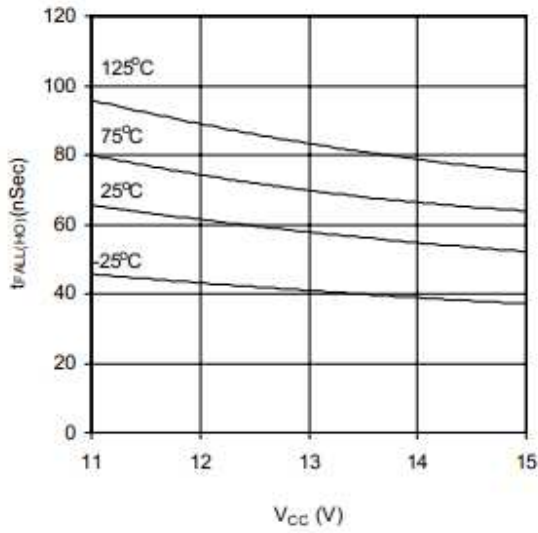

Graph 25.  $t_{FALL(HO)}$  vs  $V_{CC}$  vs Temperature (IR2156)

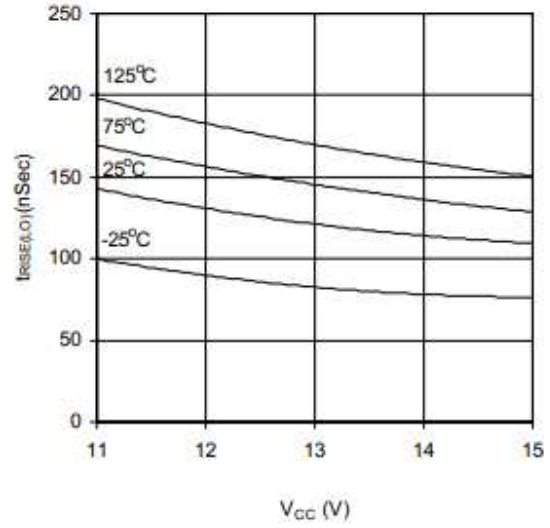

Graph 26.  $t_{RISE(LO)}$  vs  $V_{CC}$  vs Temperature (IR2156)

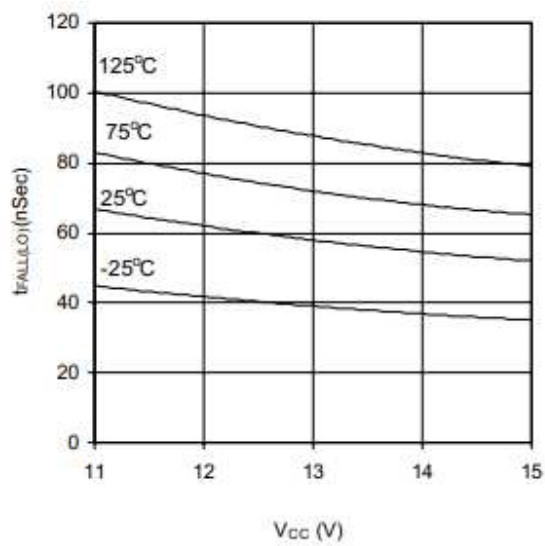

Graph 27.  $t_{FALL(LO)}$  vs  $V_{CC}$  vs Temperature (IR2156)



## Functional Description

### Under-voltage Lock-out Mode (UVLO)

The under-voltage lock-out mode (UVLO) is defined as the state the IC is in when VCC is below the turn-on threshold of the IC. To identify the different modes of the IC, refer to the State Diagram shown on page 2 of this document. The IR2156 undervoltage lock-out is designed to maintain an ultra low supply current of less than 200uA, and to guarantee the IC is fully functional before the high and low side output drivers are activated. Figure 1 shows an efficient supply voltage using the start-up current of the IRS2156 together with a charge pump from the ballast output stage ( $R_{SUPPLY}$ ,  $C_{VCC}$ ,  $D_{CP1}$  and  $D_{CP2}$ ).

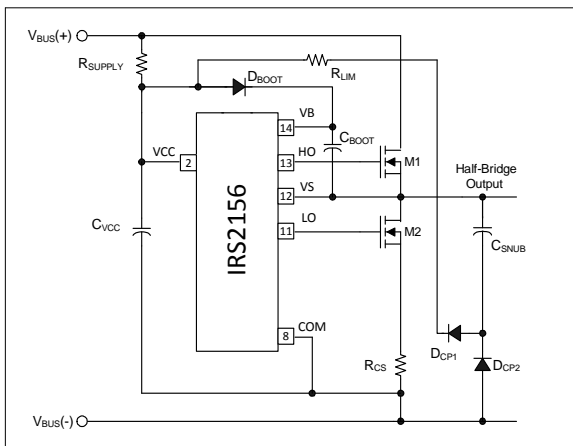

Figure 1, Start-up and supply circuitry.

The start-up capacitor ( $C_{VCC}$ ) is charged by current through supply resistor ( $R_{SUPPLY}$ ) minus the start-up current drawn by the IC. This resistor is chosen to provide 2X the maximum start-up current to guarantee ballast start-up at low line input voltage. Once the capacitor voltage on VCC reaches the start-up threshold  $V_{CCUV+}$ , and the SD pin is below  $V_{SDTH-}$ , the IC turns on and HO and LO begin to oscillate. The capacitor begins to discharge due to the increase in IC operating current (Figure 2).

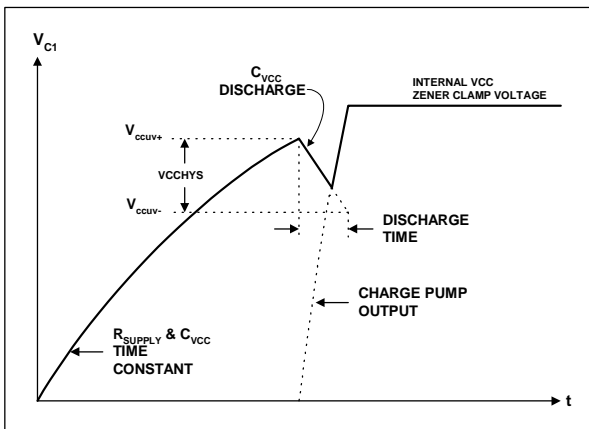

Figure 2, Supply capacitor ( $C_{VCC}$ ) voltage.

During the discharge cycle, the rectified current from the charge pump charges the capacitor above the IC turn-off threshold. The charge pump and the internal 15.6V zener clamp of the IC take over as the supply voltage. The start-up capacitor and snubber capacitor must be selected such that enough supply

current is available over all ballast operating conditions. An external bootstrap diode ( $D_{BOOT}$ ) and the supply capacitor ( $C_{BOOT}$ ) comprise the supply voltage for the high side driver circuitry. To guarantee that the high-side supply is charged up before the first pulse on pin HO, the first pulse from the output drivers comes from the LO pin. During undervoltage lock-out mode, the high- and low-side driver outputs HO and LO are both low, pin CT is connected internally to COM to disable the oscillator, and pin CPH is connected internally to COM for resetting the preheat time.

### Preheat Mode (PH)

The preheat mode is defined as the state the IC is in when the lamp filaments are being heated to their correct emission temperature. This is necessary for maximizing lamp life and reducing the required ignition voltage. The IR2156 enters preheat mode when VCC exceeds the  $V_{CCUV+}$  positive-going threshold. HO and LO begin to oscillate at the preheat frequency with 50% duty cycle and with a dead-time which is set by the value of the external timing capacitor, CT, and internal deadtime resistor, RDT. Pin CPH is disconnected from COM and an internal 4uA current source (Figure 3) charges the external preheat timing capacitor on CPH linearly. The over-current protection on pin CS is disabled during preheat.

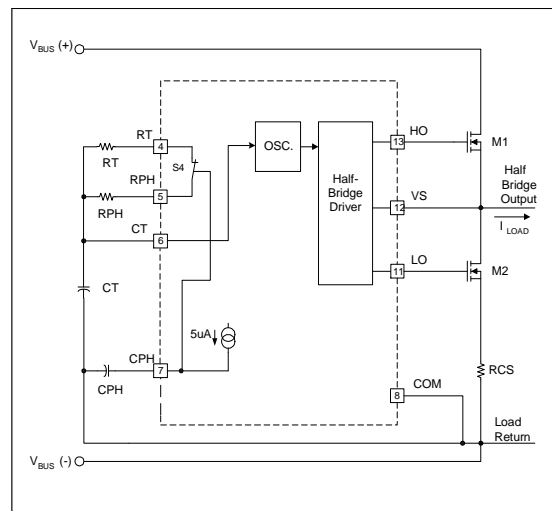

Figure 3, Preheat circuitry

The preheat frequency is determined by the parallel combination of resistors RT and RPH, together with timing capacitor CT. CT charges and discharges between 1/3 and 3/5 of VCC (see Timing Diagram, page 9). CT is charged exponentially through the parallel combination of RT and RPH connected internally to VCC through MOSFET S1. The charge time of CT from 1/3 to 3/5 VCC is the on-time of the respective output gate driver, HO or LO. Once CT exceeds 3/5 VCC, MOSFET S1 is turned off, disconnecting RT and RPH from VCC. CT is then discharged exponentially through an internal resistor, RDT, through MOSFET S3 to COM. The discharge time of CT from 3/5 to 1/3 VCC is the dead-time (both off) of the output gate drivers, HO and LO. The selected value of CT together with RDT therefore program the desired dead-time (see Design Equations, page 12, Equations 1 and 2). Once CT discharges below 1/3 VCC, MOSFET S3 is turned off, disconnecting RDT from COM, and MOSFET S1 is turned on, connecting RT and RPH again to VCC. The frequency remains at the preheat frequency until the voltage on pin CPH exceeds 13V and the IC enters Ignition Mode. During the preheat mode, both the over-current protection and the

DC bus under-voltage reset are enabled when pin CPH exceeds 7.5V.

## Ignition Mode (IGN)

The ignition mode is defined as the state the IC is in when a high voltage is being established across the lamp necessary for igniting the lamp. The IR2156 enters ignition mode when the voltage on pin CPH exceeds 13V.

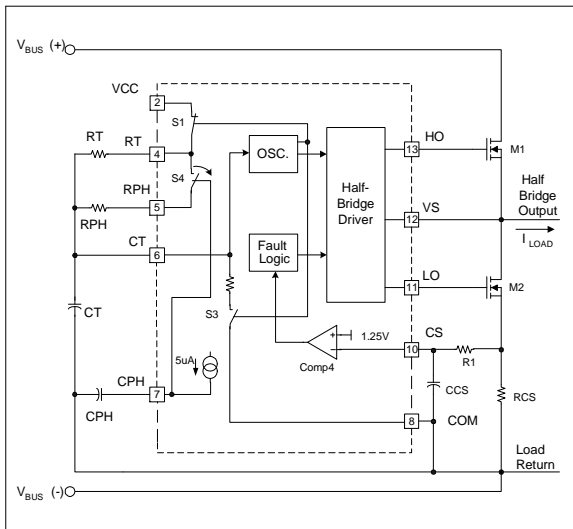

Figure 4, Ignition circuitry.

Pin CPH is connected internally to the gate of a p-channel MOSFET (S4) (see Figure 4) that connects pin RPH with pin RT. As pin CPH exceeds 13V, the gate-to-source voltage of MOSFET S4 begins to fall below the turn-on threshold of S4. As pin CPH continues to ramp towards VCC, switch S4 turns off slowly. This results in resistor RPH being disconnected smoothly from resistor RT, which causes the operating frequency to ramp smoothly from the preheat frequency, through the ignition frequency, to the final run frequency. The over-current threshold on pin CS will protect the ballast against a non-strike or open-filament lamp fault condition. The voltage on pin CS is defined by the lower half-bridge MOSFET current flowing through the external current sensing resistor RCS. The resistor RCS therefore programs the maximum allowable peak ignition current (and therefore peak ignition voltage) of the ballast output stage. The peak ignition current must not exceed the maximum allowable current ratings of the output stage MOSFETs. Should this voltage exceed the internal threshold of 1.3V, the IC will enter FAULT mode and both gate driver outputs HO and LO will be latched low.

## Run Mode (RUN)

Once the lamp has successfully ignited, the ballast enters run mode. The run mode is defined as the state the IC is in when the lamp arc is established and the lamp is being driven to a given power level. The run mode oscillating frequency is determined by the timing resistor RT and timing capacitor CT (see Design Equations, page 12, Equations 3 and 4). Should hard-switching occur at the half-bridge at any time due to an open-filament or lamp removal, the voltage across the current sensing resistor, RCS, will exceed the internal threshold of 1.3 volts and the IC will enter FAULT mode. Both gate driver outputs, HO and LO, will be latched low.

## DC Bus Under-voltage Reset

Should the DC bus decrease too low during a brown-out line condition or over-load condition, the resonant output stage to the lamp can shift near or below resonance. This can produce hard-switching at the half-bridge which can damage the half-bridge switches. To protect against this, pin VDC measures the DC bus voltage and pulls down on pin CPH linearly as the voltage on pin VDC decreases 10.9V below VCC. This causes the p-channel MOSFET S4 (Figure 4) to close as the DC bus decreases and the frequency to shift higher to a safe operating point above resonance. The DC bus level at which the frequency shifting occurs is set by the external RBUS resistor and internal RVDC resistor. By pulling down on pin CPH, the ignition ramp is also reset. Therefore, should the lamp extinguish due to very low DC bus levels, the lamp will be automatically ignited as the DC bus increases again. The internal RVDC resistor is connected between pin VDC and COM when CPH exceeds 7.5V (during preheat mode).

## Fault Mode (FAULT)

Should the voltage at the current sensing pin, CS, exceed 1.3V at any time after the preheat mode, the IC enters fault mode and both gate driver outputs, HO and LO, are latched in the 'low' state. CPH is discharged to COM for resetting the preheat time, and CT is discharged to COM for disabling the oscillator. To exit fault mode, VCC must be recycled back below the UVLO negative-going turn-off threshold, or, the shutdown pin, SD, must be pulled above VSDTH+. Either of these will force the IC to enter UVLO mode (see State Diagram, page 2). Once VCC is above VCCUV+ and SD is below 4.5V, the IC will begin oscillating again in the preheat mode.

## Design Equations

Note: The results from the following design equations can differ slightly from experimental measurements due to IC tolerances, component tolerances, and oscillator over- and under-shoot due to internal comparator response time.

For additional design support for different lamp types and AC line input configurations, including component calculations, schematics, bill of materials and inductor specifications, please download IR's Ballast Design Assistant (BDA) software at [www.irf.com](http://www.irf.com).

### Step 1: Program Dead-time

The dead-time between the gate driver outputs HO and LO is programmed with timing capacitor CT and an internal dead-time resistor RDT. The dead-time is the discharge time of capacitor CT from 3/5VCC to 1/3VCC and is given as:

$$t_{DT} = C_T \cdot 2000 \quad [\text{Seconds}] \quad (1)$$

Or,

$$C_T = \frac{t_{DT}}{2000} \quad [\text{Farads}] \quad (2)$$

### Step 2: Program Run Frequency

The final run frequency is programmed with timing resistor RT and timing capacitor CT. The charge time of capacitor CT from 1/3VCC to 3/5VCC determines the on-time of HO and LO gate driver outputs. The run frequency is therefore given as:

$$f_{RUN} = \frac{1}{2 \cdot C_T (0.6 \cdot R_T + 2000)} \quad [\text{Hertz}] \quad (3)$$

Or,

$$R_T = \frac{1}{1.12 \cdot C_T \cdot f_{RUN}} - 3333 \quad [\text{Ohms}] \quad (4)$$

### Step 3: Program Preheat Frequency

The preheat frequency is programmed with timing resistors RT and RPH, and timing capacitor CT. The timing resistors are

connected in parallel internally for the duration of the preheat time. The preheat frequency is therefore given as:

$$f_{PH} = \frac{1}{2 \cdot C_T \cdot \left( \frac{0.51 \cdot R_T \cdot R_{PH}}{R_T + R_{PH}} + 2000 \right)} \quad [\text{Hertz}] \quad (5)$$

Or,

$$R_{PH} = \frac{\left( \frac{1}{1.12 \cdot C_T \cdot f_{PH}} - 3333 \right) \cdot R_T}{R_T - \left( \frac{1}{1.12 \cdot C_T \cdot f_{PH}} - 3333 \right)} \quad [\text{Ohms}] \quad (6)$$

### Step 4: Program Preheat Time

The preheat time is defined by the time it takes for the capacitor on pin CPH to charge up to 13 volts. An internal current source of 5uA flows out of pin CPH. The preheat time is therefore given as:

$$t_{PH} = C_{PH} \cdot 3.02e6 \quad [\text{Seconds}] \quad (7)$$

Or,

$$C_{PH} = t_{PH} \cdot 0.33e-6 \quad [\text{Farads}] \quad (8)$$

### Step 5: Program Maximum Ignition Current

The maximum ignition current is programmed with the external resistor RCS and an internal threshold of 1.25 volts (VCSTH+). This threshold determines the over-current limit of the ballast, which can be exceeded when the frequency ramps down towards resonance during ignition and the lamp does not ignite. The maximum ignition current is given as:

$$I_{IGN} = \frac{1.25}{R_{CS}} \quad [\text{Amps Peak}] \quad (9)$$

Or,

$$R_{CS} = \frac{1.25}{I_{IGN}} \quad [\text{Ohms}] \quad (10)$$

# IR2156(S)PbF

## Case Outline

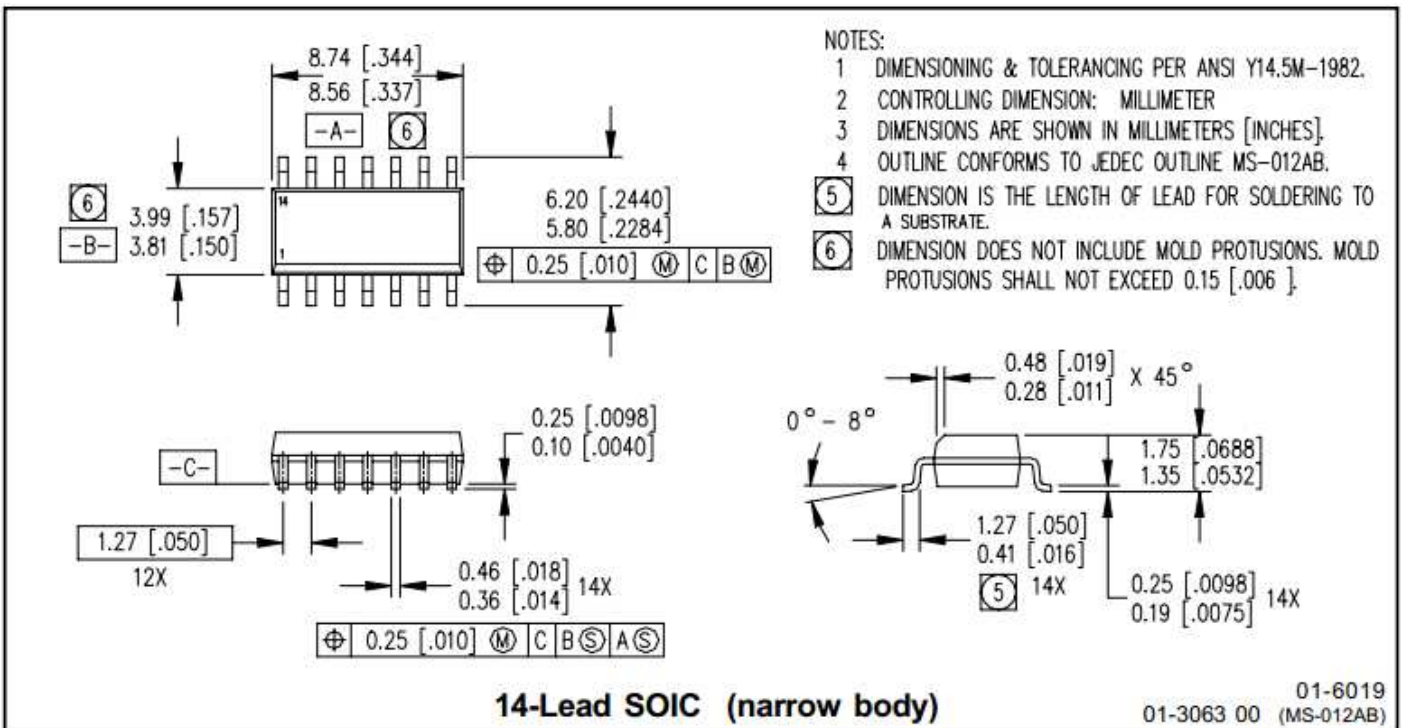
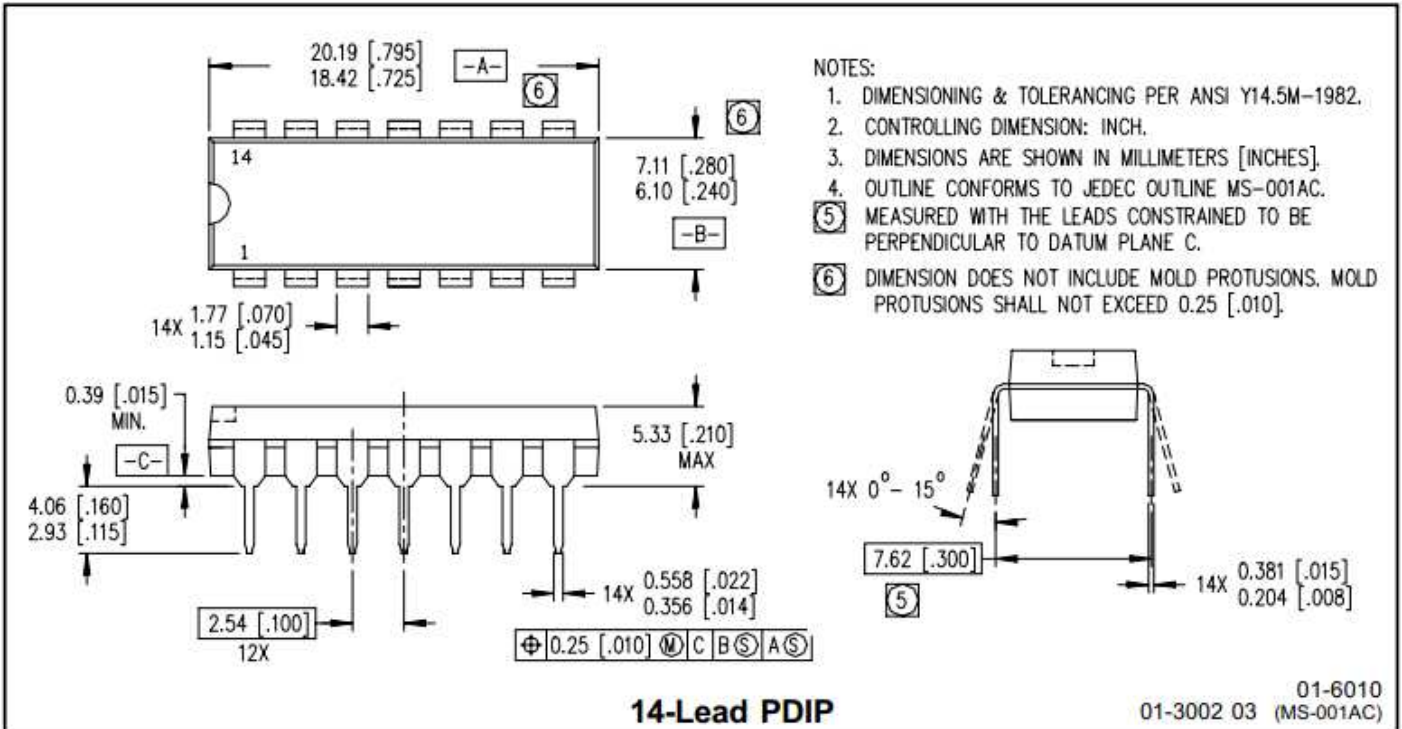

# IR2156(S)PbF

Qualification: Lead-free MSL3, industrial

International  
**IOR** Rectifier

<http://www.irf.com>

Data and specifications subject to change without notice.  
Sales Offices, Agents and Distributors in Major Cities Throughout the World.  
© 2012 International Rectifier Printed in U.S.A

# Mouser Electronics

Authorized Distributor

Click to View Pricing, Inventory, Delivery & Lifecycle Information:

[International Rectifier:](#)

[IR2156SPBF](#) [IR2156PBF](#) [IR2156STRPBF](#)